

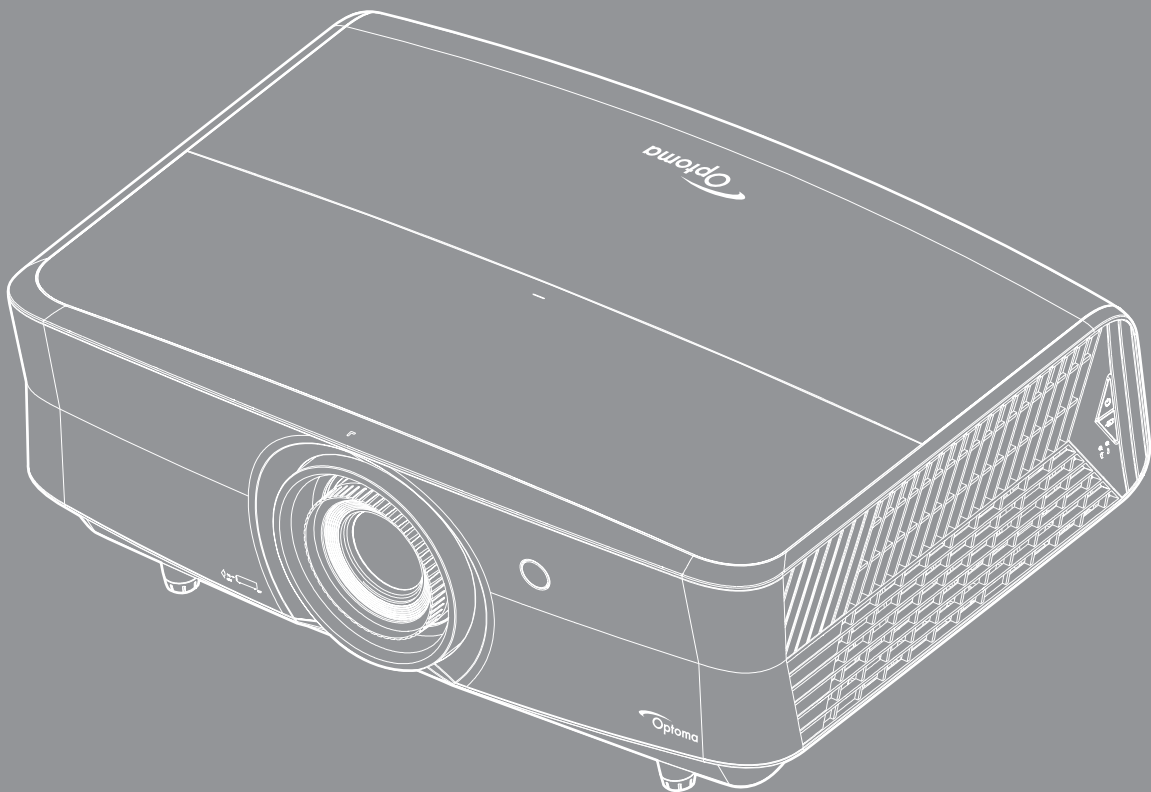

# DLP® Projector



# TABLE OF CONTENTS

<b>SAFETY .....</b>	<b>4</b>
<i>Important Safety Instruction.....</i>	<i>4</i>
<i>Laser Radiation Safety Information .....</i>	<i>5</i>
<i>Copyright .....</i>	<i>5</i>
<i>Disclaimer.....</i>	<i>6</i>
<i>Trademark Recognition .....</i>	<i>6</i>
<i>FCC .....</i>	<i>6</i>
<i>Declaration of Conformity for EU countries .....</i>	<i>7</i>
<i>WEEE.....</i>	<i>7</i>
<b>INTRODUCTION .....</b>	<b>8</b>
<i>Package Overview.....</i>	<i>8</i>
<i>Standard accessories .....</i>	<i>8</i>
<i>Optional accessories .....</i>	<i>8</i>
<i>Product Overview .....</i>	<i>9</i>
<i>Connections.....</i>	<i>10</i>
<i>Keypad .....</i>	<i>11</i>
<i>Remote control.....</i>	<i>12</i>
<b>SETUP AND INSTALLATION .....</b>	<b>13</b>
<i>Installing the projector .....</i>	<i>13</i>
<i>Connecting sources to the projector.....</i>	<i>14</i>
<i>Adjusting the projector image .....</i>	<i>15</i>
<i>Remote setup .....</i>	<i>16</i>
<b>USING THE PROJECTOR.....</b>	<b>18</b>
<i>Powering on / off the projector.....</i>	<i>18</i>
<i>Selecting an input source .....</i>	<i>19</i>
<b>USING THE PROJECTOR.....</b>	<b>20</b>
<i>Menu navigation and features .....</i>	<i>20</i>
<i>OSD Menu tree.....</i>	<i>21</i>
<i>Display image settings menu.....</i>	<i>29</i>
<i>Display 3D menu .....</i>	<i>32</i>
<i>Display aspect ratio menu .....</i>	<i>32</i>
<i>Display edge mask menu .....</i>	<i>33</i>
<i>Display digital zoom menu.....</i>	<i>33</i>
<i>Display image shift menu .....</i>	<i>33</i>
<i>Audio internal speaker menu.....</i>	<i>34</i>
<i>Audio mute menu .....</i>	<i>34</i>
<i>Audio volume menu.....</i>	<i>34</i>
<i>Setup projection menu.....</i>	<i>34</i>

<i>Setup filter settings menu</i> .....	34
<i>Setup power settings menu</i> .....	35
<i>Setup security menu</i> .....	35
<i>Setup test pattern menu</i> .....	35
<i>Setup remote settings menu</i> .....	36
<i>Setup projector ID menu</i> .....	36
<i>Setup 12V trigger menu</i> .....	36
<i>Setup options menu</i> .....	36
<i>Setup reset OSD menu</i> .....	37
<i>Network LAN menu</i> .....	37
<i>Network control menu</i> .....	39
<i>Setup network control settings menu</i> .....	39
<i>Info menu</i> .....	45



## **MAINTENANCE ..... 46**

<i>Installing and cleaning the dust filter</i> .....	46
--	----

## **ADDITIONAL INFORMATION ..... 47**

<i>Compatible resolutions</i> .....	47
<i>Image size and projection distance</i> .....	48
<i>Projector dimensions and ceiling mount installation</i> .....	50
<i>IR remote codes</i> .....	51
<i>Troubleshooting</i> .....	53
<i>Warning indicators</i> .....	54
<i>Specifications</i> .....	56
<i>Optoma global offices</i> .....	57

# SAFETY

	The lightning flash with arrow head within an equilateral triangle is intended to alert the user to the presence of uninsulated "dangerous voltage" within the product's enclosure that may be of sufficient magnitude to constitute a risk of electric shock to persons.
	The exclamation point within an equilateral triangle is intended to alert the user to the presence of important operating and maintenance (servicing) instructions in the literature accompanying the appliance.

Please follow all warnings, precautions and maintenance as recommended in this user's guide.

## Important Safety Instruction

- 
- Do not block any ventilation openings. To ensure reliable operation of the projector and to protect from over heating, it is recommended to install the projector in a location that does not block ventilation. As an example, do not place the projector on a crowded coffee table, sofa, bed, etc. Do not put the projector in an enclosure such as a book case or a cabinet that restricts air flow.
- To reduce the risk of fire and/or electric shock, do not expose the projector to rain or moisture. Do not install near heat sources such as radiators, heaters, stoves or any other apparatus such as amplifiers that emits heat.
- Do not let objects or liquids enter the projector. They may touch dangerous voltage points and short out parts that could result in fire or electric shock.
- Do not use under the following conditions:
  - In extremely hot, cold or humid environments.
    - (i) Ensure that the ambient room temperature is within 5°C ~ 40°C
    - (ii) Relative humidity is 10% ~ 85%
  - In areas susceptible to excessive dust and dirt.
  - Near any appliance generating a strong magnetic field.
  - In direct sunlight.
- Do not use the unit if it has been physically damaged or abused. Physical damage/abuse would be (but not limited to):
  - Unit has been dropped.
  - Power supply cord or plug has been damaged.
  - Liquid has been spilled on to the projector.
  - Projector has been exposed to rain or moisture.
  - Something has fallen in the projector or something is loose inside.
- Do not place the projector on an unstable surface. The projector may fall over resulting in injury or the projector may become damaged.
- Do not block the light coming out of the projector lens when in operation. The light will heat the object and may melt, cause burns or start a fire.
- Please do not open or disassemble the projector as this may cause electric shock.
- Do not attempt to service the unit yourself. Opening or removing covers may expose you to dangerous voltages or other hazards. Please call Optoma before you send the unit for repair.
- See projector enclosure for safety related markings.
- The unit should only be repaired by authorized service personnel.
- Only use attachments/accessories specified by the manufacturer.
- Do not look into straight into the projector lens during operation. The bright light may harm your eyes.



- This projector will detect the life of the light source itself.
- When switching the projector off, please ensure the cooling cycle has been completed before disconnecting power. Allow 90 seconds for the projector to cool down.
- Turn off and unplug the power plug from the AC outlet before cleaning the product.
- Use a soft dry cloth with mild detergent to clean the display housing. Do not use abrasive cleaners, waxes or solvents to clean the unit.
- Disconnect the power plug from AC outlet if the product is not being used for a long period of time.
- Do not setup the projector in places where it might be subjected to vibration or shock.
- Do not touch the lens with bare hands.
- Remove battery/batteries from remote control before storage. If the battery/batteries are left in the remote for long periods, they may leak.
- Do not use or store the projector in places where smoke from oil or cigarettes may be present, as it can adversely affect the quality of the projector performance.
- Please follow the correct projector orientation installation as non standard installation may affect the projector performance.
- Use a power strip and or surge protector. As power outages and brown-outs can KILL devices.

## Laser Radiation Safety Information

- This product is classified as CLASS 1 LASER PRODUCT - RISK GROUP 2 of IEC60825-1 : 2014 and also complies with 21 CFR 1040.10 and 1040.11 as a Risk Group 2, LIP (Laser Illuminated Projector) as defined in IEC 62471:2006 except for deviations pursuant to Laser Notice No. 50, dated June 24, 2007.

 <p>Complies with 21 CFR 1040.10 and 1040.11 as a Risk Group 2, LIP (Laser Illuminated Projector) as defined in IEC 62471:2006 except for deviations pursuant to Laser Notice No. 50, dated June 24, 2007</p>				
IEC 60825-1:2014 CLASS 1 LASER PRODUCT RISK GROUP 2	IEC 60825-1:2014 PRODUIT LASER DE CLASSE 1 GROUPE DE RISQUE 2	IEC 60825-1:2014 1类激光产品 危险组2	IEC 60825-1:2014 1등급 레이저 제품 위험 그룹 2	IEC 60825-1:2014 クラス1レーザー製品 リスクグループ 2
<b>CAUTION</b> Possibly hazardous optical radiation emitted from this product. Do not stare at beam. May be harmful to the eye.	<b>AVERTISSEMENT</b> Radiation optique à danger potentiel émise par ce produit. Ne regardez pas directement le faisceau laser. Ceci pourrait être nocif pour votre oeil.	<b>注意</b> 此产品可能会产生危险光辐射。请勿直视操作光束，以免对眼睛损害。	<b>주의</b> 이 제품으로부터 인체에 위험한 광선이 방사될 수 있음. 광원을 정면으로 바라보지 마시오. 눈에 심각한 손상을 입을 수 있음.	<b>注意</b> 本製品より危険となる光放射あり。ビームをのぞき込まないこと。眼に有害となる可能性あり。



### Failure to comply with the following could result in death or serious injury.

- This projector has built-in Class 4 laser module. Disassembly or modification is very dangerous and should never be attempted.
- Any operation or adjustment not specifically instructed by the user's guide creates the risk of hazardous laser radiation exposure.
- Do not open or disassemble the projector as this may cause damage by the exposure of laser radiation.
- Do not stare into beam when the projector is on. The bright light may result in permanent eye damage.
- When turning on the projector, make sure no one within projection range is looking at the lens.
- Without following the control, adjustment or operation procedure may cause damage by the exposure of laser radiation.
- Adequate instructions for assembly, operation, and maintenance, including clear warnings concerning precautions to avoid possible exposure to laser.

## Copyright

This publication, including all photographs, illustrations and software, is protected under international copyright laws, with all rights reserved. Neither this manual, nor any of the material contained herein, may be reproduced without written consent of the author.

## Disclaimer

The information in this document is subject to change without notice. The manufacturer makes no representations or warranties with respect to the contents hereof and specifically disclaims any implied warranties of merchantability or fitness for any particular purpose. The manufacturer reserves the right to revise this publication and to make changes from time to time in the content hereof without obligation of the manufacturer to notify any person of such revision or changes.

## Trademark Recognition

Kensington is a U.S. registered trademark of ACCO Brand Corporation with issued registrations and pending applications in other countries throughout the world.

HDMI, the HDMI Logo, and High-Definition Multimedia Interface are trademarks or registered trademarks of HDMI Licensing LLC in the United States and other countries.

DLP®, DLP Link and the DLP logo are registered trademarks of Texas Instruments and BrilliantColor™ is a trademark of Texas Instruments.

All other product names used in this manual are the properties of their respective owners and are Acknowledged.

MHL, Mobile High-Definition Link and the MHL Logo are trademarks or registered trademarks of MHL Licensing, LLC.

## FCC

This device has been tested and found to comply with the limits for a Class B digital device pursuant to Part 15 of the FCC rules. These limits are designed to provide reasonable protection against harmful interference in a residential installation. This device generates, uses and can radiate radio frequency energy and, if not installed and used in accordance with the instructions, may cause harmful interference to radio communications.

However, there is no guarantee that interference will not occur in a particular installation. If this device does cause harmful interference to radio or television reception, which can be determined by turning the device off and on is encouraged to try to correct the interference by one or more of the following measures:

- Reorient or relocate the receiving antenna.
- Increase the separation between the device and receiver.
- Connect the device into an outlet on a circuit different from that to which the receiver is connected.
- Consult the dealer or an experienced radio/television technician for help.

### **Notice: Shielded cables**

All connections to other computing devices must be made using shielded cables to maintain compliance with FCC regulations.

### **Caution**

Changes or modifications not expressly approved by the manufacturer could void the user's authority, which is granted by the Federal Communications Commission, to operate this projector.

### **Operation Conditions**

This device complies with Part 15 of the FCC Rules. Operation is subject to the following two conditions:

1. This device may not cause harmful interference and
2. This device must accept any interference received, including interference that may cause undesired operation.

### **Notice: Canadian users**

This Class B digital apparatus complies with Canadian ICES-003.

Remarque à l'intention des utilisateurs canadiens

Cet appareil numérique de la classe B est conforme à la norme NMB-003 du Canada.

## Declaration of Conformity for EU countries

- EMC Directive 2014/30/EC (including amendments)
- Low Voltage Directive 2014/35/EC
- R & TTE Directive 1999/5/EC (if product has RF function)

## WEEE



### Disposal instructions

Do not throw this electronic device into the trash when discarding. To minimize pollution and ensure utmost protection of the global environment, please recycle it.

# INTRODUCTION

## Package Overview

Carefully unpack and verify that you have the items listed below under standard accessories. Some of the items under optional accessories may not be available depending on the model, specification and your region of purchase. Please check with your place of purchase. Some accessories may vary from region to region.

The warranty card is only supplied in some specific regions. Please consult your dealer for detailed information.

## Standard accessories

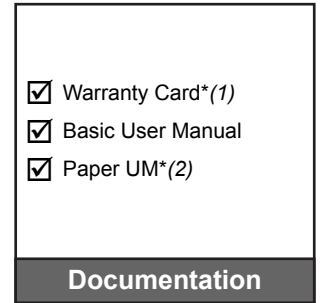
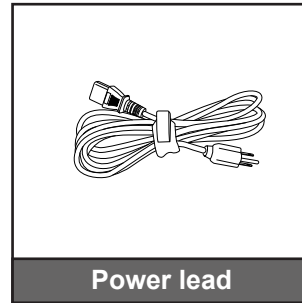
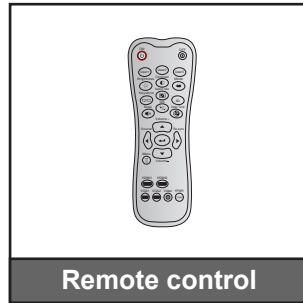
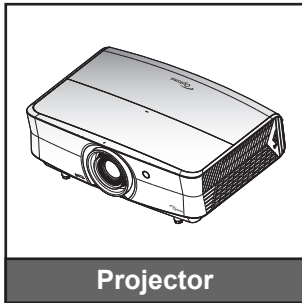

### Note:

- *The remote control is shipped with the battery.*
- *\*(1) For European warranty Information, please visit [www.optoma.com](http://www.optoma.com).*
- *\*(2) Available only for Asian region.*
- *\*(3) Available only for USA and Asian regions.*

## Optional accessories

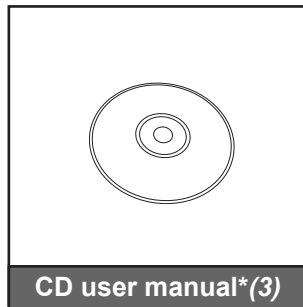
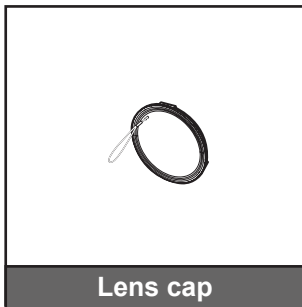

**Note:** *Optional accessories vary depending on model, specification and region.*

# INTRODUCTION

## Product Overview

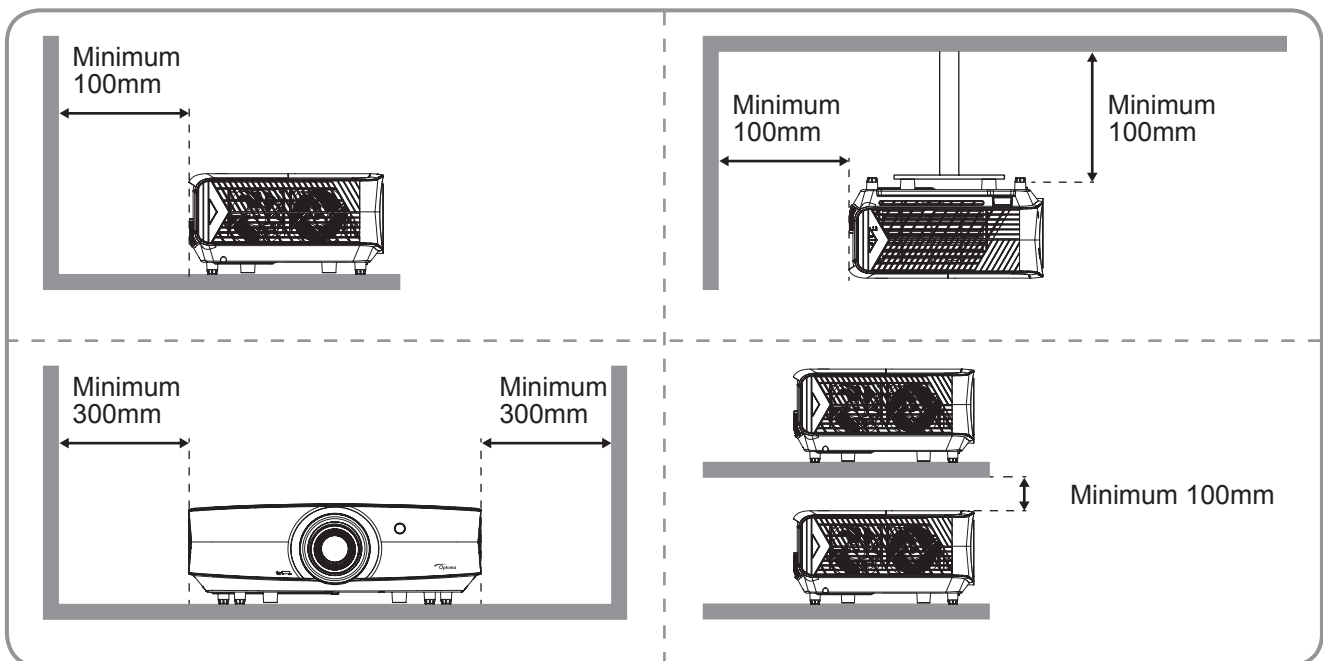
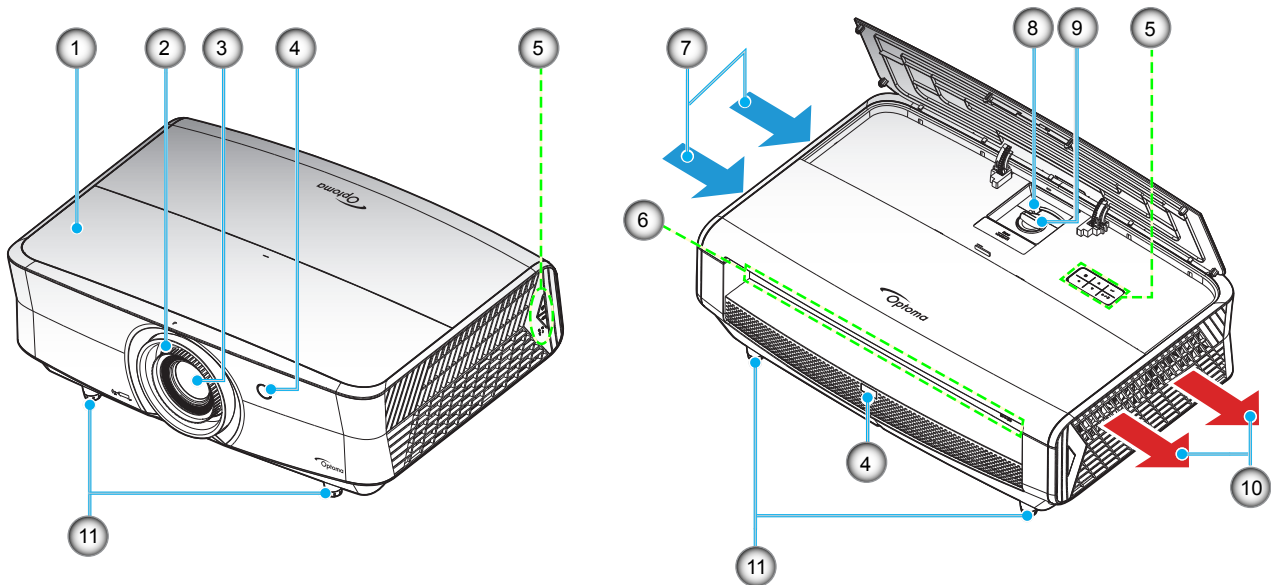

**Note:**

- Do not block projector intake and exhaust vents.
- When operating the projector in an enclosed space, allow at least 30 cm clearance around the intake and exhaust vents.

No	Item	No	Item
1.	Top Cover	7.	Ventilation (inlet)
2.	Focus Ring	8.	Zoom Lever
3.	Lens	9.	Lens Shift Dial
4.	IR Receiver	10.	Ventilation (outlet)
5.	Keypad	11.	Tilt-Adjustment Foot
6.	Input / Output		

# INTRODUCTION

## Connections

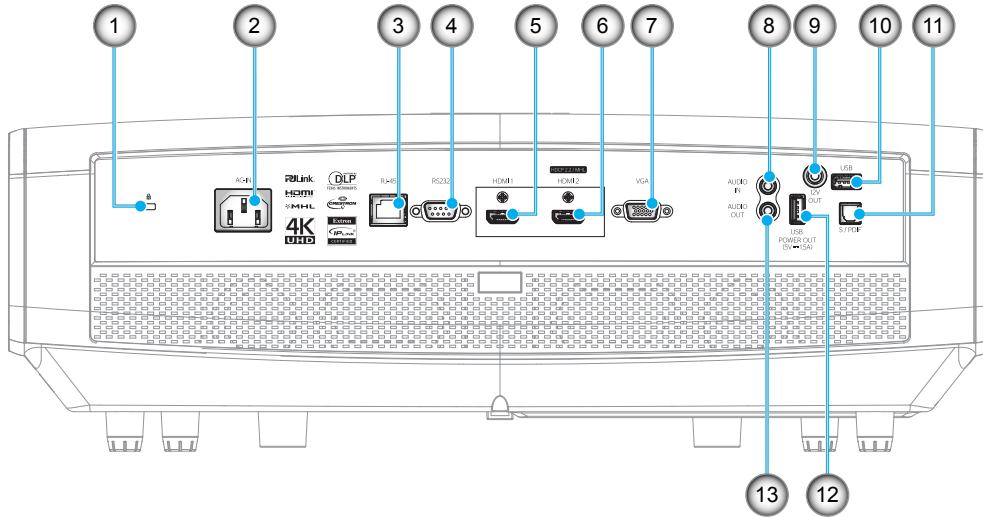

No	Item	No	Item
1.	Kensington™ Lock Port	8.	AUDIO IN Connector
2.	Power Socket	9.	12V OUT Connector
3.	RJ-45 Connector	10.	USB Type A / Service Connector
4.	RS232 Connector	11.	S/PDIF Connector
5.	HDMI 1 Connector	12.	USB Power Out (5V---1.5A)
6.	HDMI 2 (HDCP2.2) / MHL Connector (*)	13.	AUDIO OUT Connector
7.	VGA Connector		

### Note:

- *USB Type A supports mouse / service capability.*
- *Remote mouse requires special remote control.*
- *(\*)Only HDMI 2 (HDCP2.2) connector supports 4K (Ultra HD) at 60Hz refresh rate.*

# INTRODUCTION

## Keypad

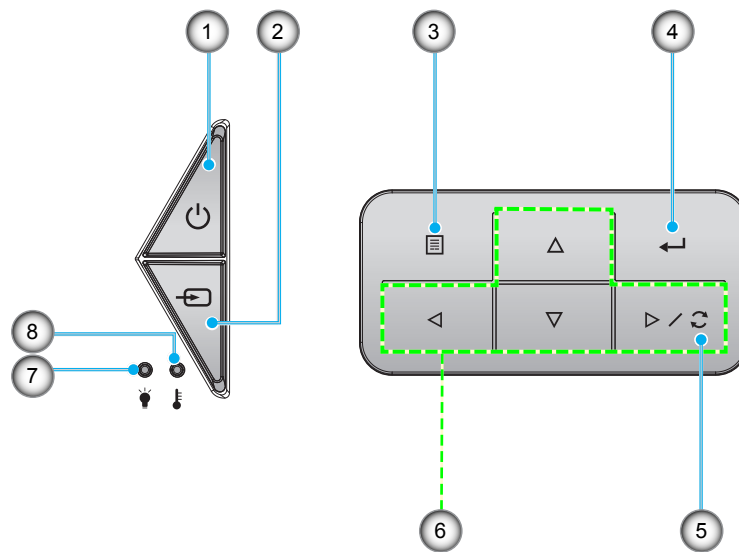

No	Item	No	Item
1.	Power and On/Standby LED	5.	Re-Sync
2.	Source	6.	Four Directional Select Keys
3.	Menu	7.	Laser LED
4.	Enter	8.	Temp LED

# INTRODUCTION

## Remote control

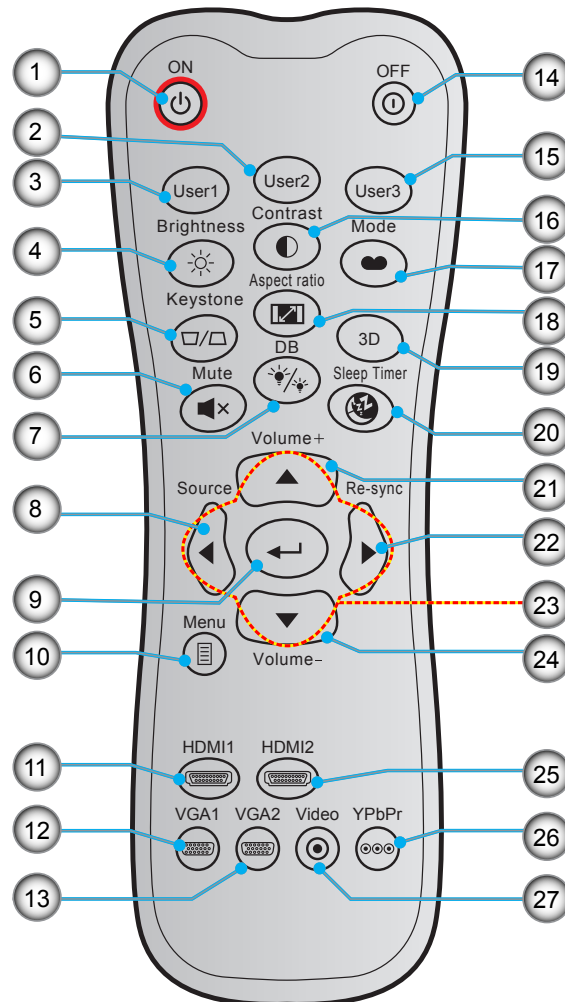

No	Item	No	Item
1.	Power On	15.	User 3
2.	User 2	16.	Contrast
3.	User 1	17.	Display Mode
4.	Brightness	18.	Aspect Ratio
5.	Keystone (not supported)	19.	3D Menu On / Off (not supported)
6.	Mute	20.	Sleep Timer
7.	DB (Dynamic Black)	21.	Volume +
8.	Source	22.	Re-Sync
9.	Enter	23.	Four Directional Select Keys
10.	Menu	24.	Volume -
11.	HDMI1	25.	HDMI2
12.	VGA1	26.	YPbPr (not supported)
13.	VGA2 (not supported)	27.	Video (not supported)
14.	Power Off		

**Note:** Some keys may have no function for models that do not support these features.



# SETUP AND INSTALLATION

## Installing the projector

Your projector is designed to be installed in one of four possible positions.

Your room layout or personal preference will dictate which installation location you select. Take into consideration the size and position of your screen, the location of a suitable power outlet, as well as the location and distance between the projector and the rest of your equipment.

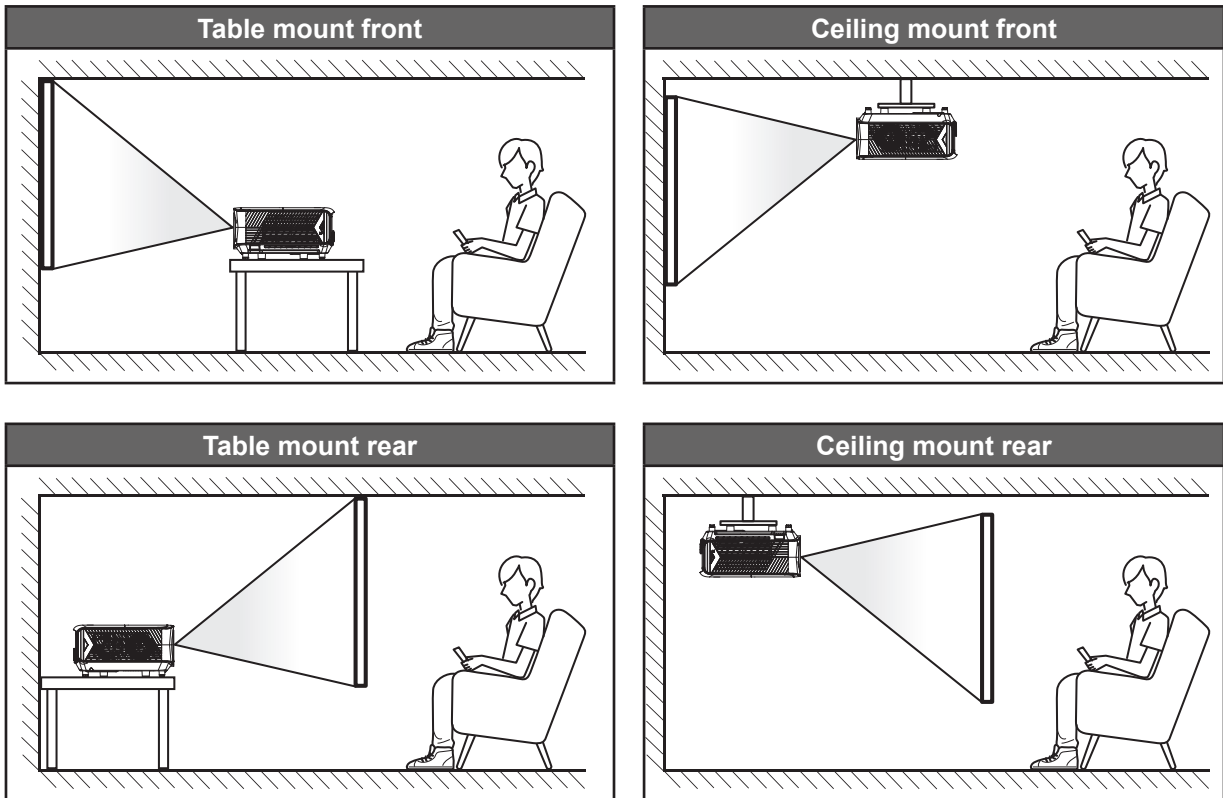

Projector should be placed flat on a surface and 90 degrees / perpendicular to the screen.

- How to determine projector location for a given screen size, please refer to distance table on pages 48-49.
- How to determine screen size for a given distance, please refer to distance table on pages 48-49.

**Note:** *The further away the projector is placed from the screen the projected image size increases and vertical offset also increases proportionally.*

### **IMPORTANT!**

*Do not operate the projector in any orientation other than table top or ceiling mount. The projector should be horizontal and not tilted either forwards/backwards or left/right. Any other orientation will invalidate the warranty and may shorten the lifetime of the projector light source or the projector itself. For non standard installation advise please contact Optoma.*

# SETUP AND INSTALLATION

## Connecting sources to the projector

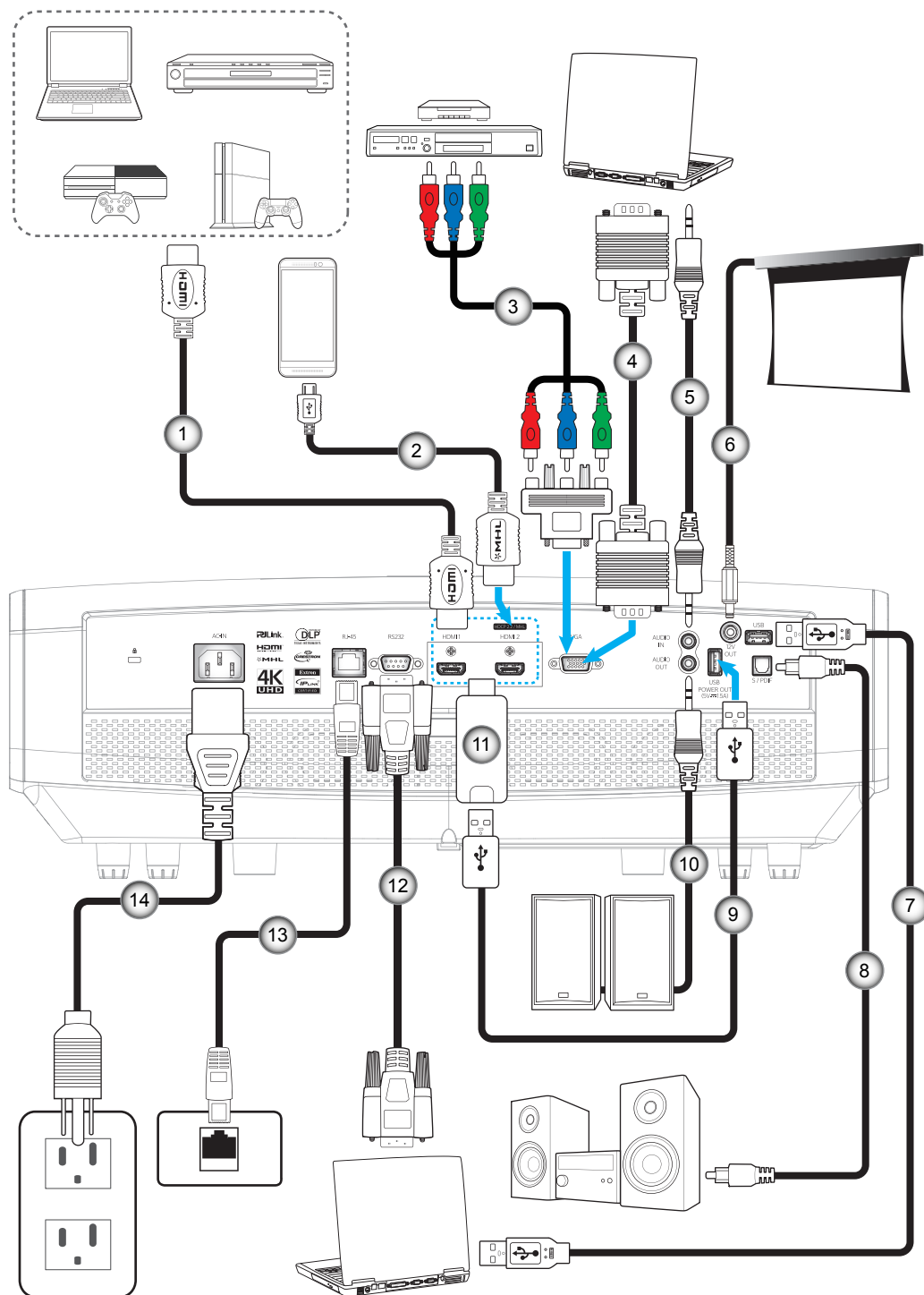

No	Item	No	Item
1.	HDMI Cable	8.	S/PDIF Out Cable
2.	HDMI / MHL Cable	9.	USB Power Cable
3.	RCA Component Cable	10.	Audio Out Cable
4.	VGA In Cable	11.	HDMI Dongle
5.	Audio In Cable	12.	RS232 Cable
6.	12V DC Jack	13.	RJ-45 Cable
7.	USB Cable	14.	Power Cord

# SETUP AND INSTALLATION

## Adjusting the projector image

### Image height

The projector is equipped with elevator feet for adjusting the image height.

1. Locate the adjustable foot you wish to adjust on the underside of the projector.
2. Rotate the adjustable foot clockwise or counterclockwise to raise or lower the projector.

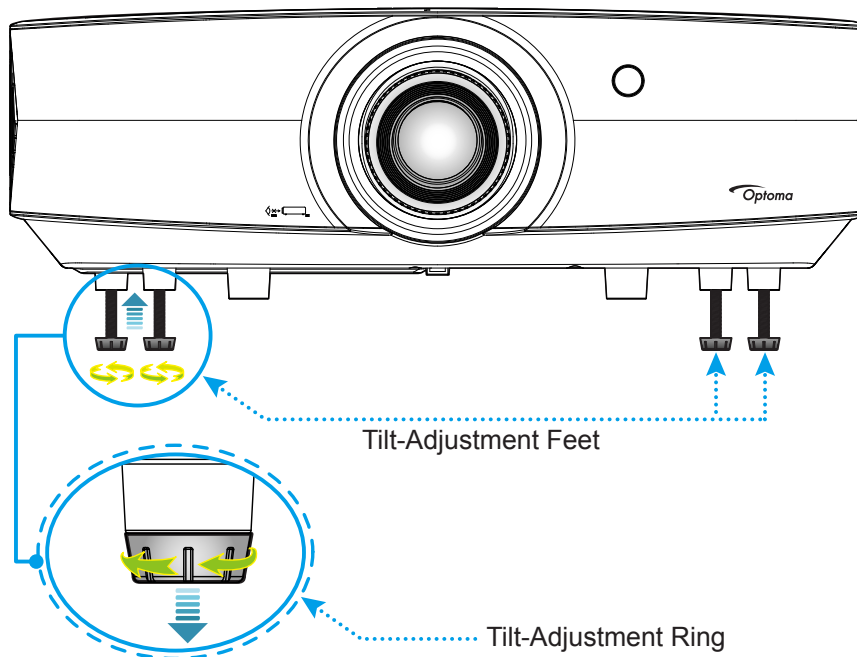

### Zoom, lens shift, and focus

- To adjust the image size and position, do the following:
  - a. Push down firmly on the middle of the top cover to unlock the latch. Then open the top cover.

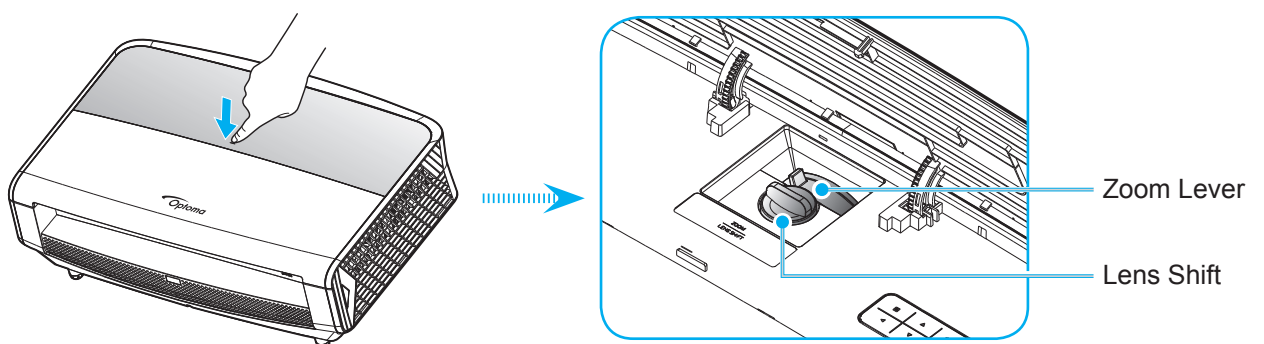

- b. To adjust the image size, turn the zoom lever clockwise or counterclockwise to increase or decrease the projected image size.
- c. To adjust the image position, turn the lens shift dial clockwise or counterclockwise to adjust the position of the projected image vertically.

# SETUP AND INSTALLATION

- To adjust the focus, turn the focus ring clockwise or counterclockwise until the image is sharp and legible.

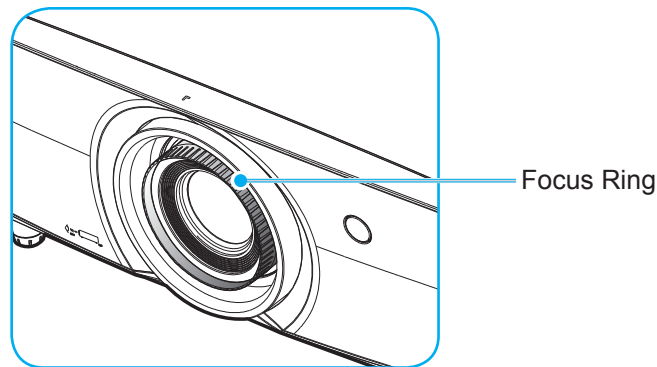

**Note:** The projector will focus at a distance of 1.3m to 9.3m.

## Remote setup

### Installing / replacing the batteries

Two AAA size batteries are supplied for the remote control.

1. Remove the battery cover on the back of the remote control.
2. Insert AAA batteries in the battery compartment as illustrated.
3. Replace back cover on remote control.

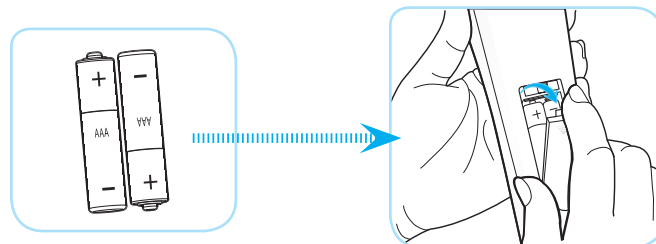

**Note:** Replace only with the same or equivalent type batteries.

### CAUTION

Improper use of batteries can result in chemical leakage or explosion. Be sure to follow the instructions below.

- Do not mix batteries of different types. Different types of batteries have different characteristics.
- Do not mix old and new batteries. Mixing old and new batteries can shorten the life of new batteries or cause chemical leakage in old batteries.
- Remove batteries as soon as they are depleted. Chemicals that leak from batteries that come in contact with skin can cause a rash. If you find any chemical leakage, wipe thoroughly with a cloth.
- The batteries supplied with this product may have a shorter life expectancy due to storage conditions.
- If you will not be using the remote control for an extended period of time, remove the batteries.
- When you dispose of the batteries, you must obey the law in the relative area or country.

# SETUP AND INSTALLATION

## Effective range

Infra-Red (IR) remote control sensor is located on the front side and rear side of the projector. Ensure to hold the remote control at an angle within 30 degrees perpendicular to the projector's IR remote control sensor to function correctly. The distance between the remote control and the sensor should not be longer than 7 meters (~ 23 feet).

- Make sure that there are no obstacles between the remote control and the IR sensor on the projector that might obstruct the infra-red beam.
- Make sure the IR transmitter of the remote control is not being shined by sunlight or fluorescent lamps directly.
- Please keep the remote controller away from fluorescent lamps for over 2 meters or the remote controller might become malfunction.
- If the remote control is closed to Inverter-Type fluorescent lamps, it might become ineffective from time to time.
- If the remote control and the projector are within a very short distance, the remote control might become ineffective.
- When you aim at the screen, the effective distance is less than 5 meters from the remote control to the screen and reflecting the IR beams back to the projector. However, the effective range might change according to screens.

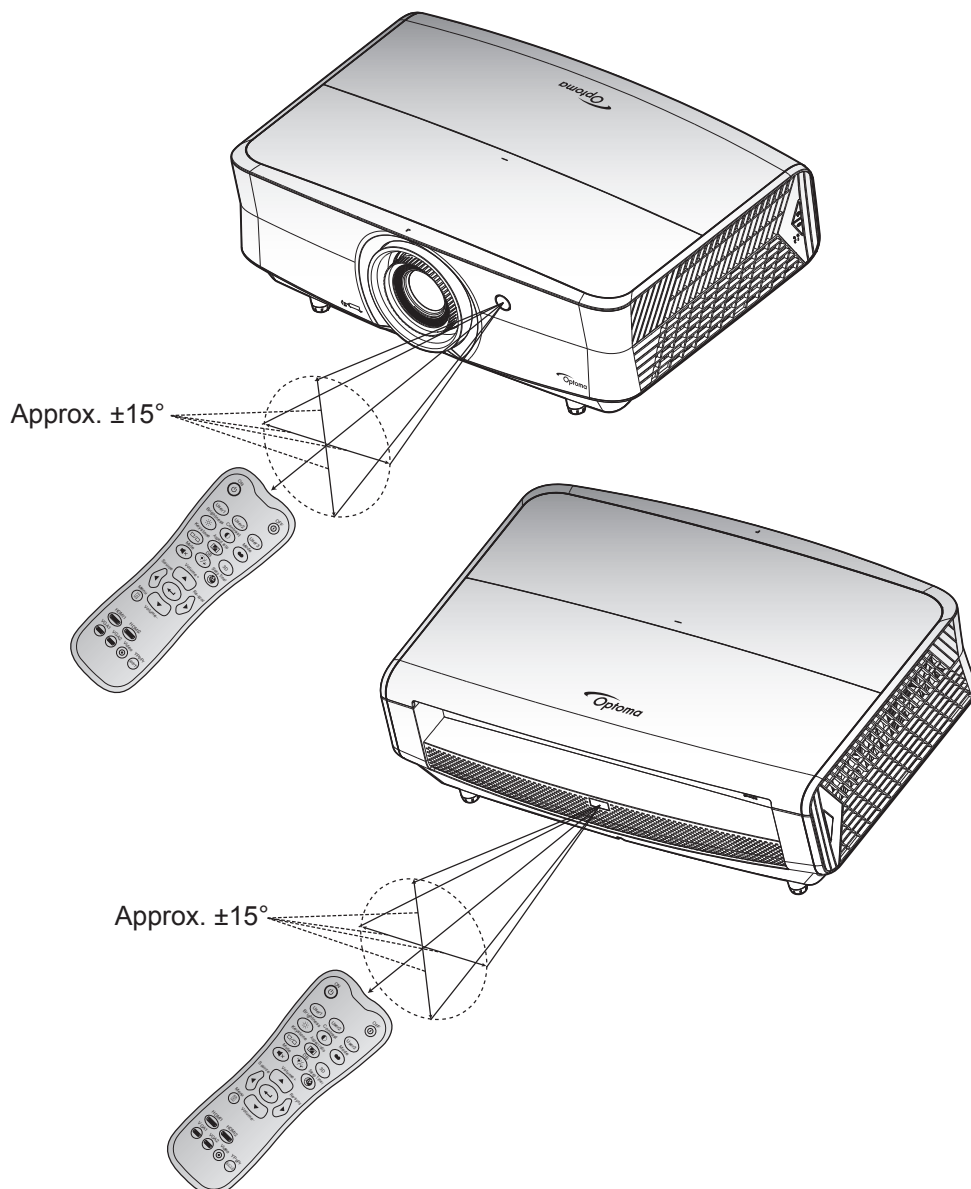

# USING THE PROJECTOR

## Powering on / off the projector

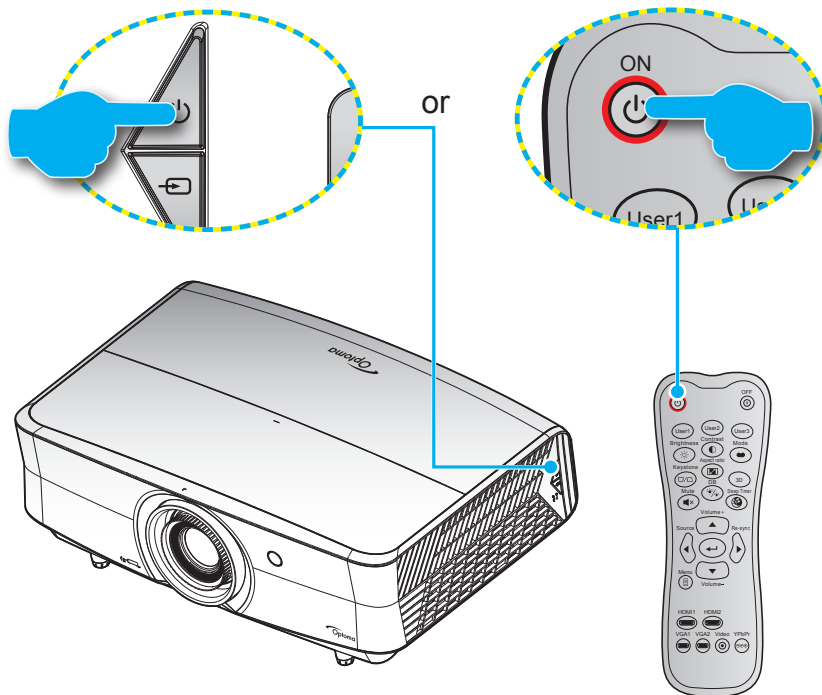

### Powering on

1. Securely connect the power lead and signal/source cable. When connected, the On/Standby LED will turn red.
2. Turn on the projector by pressing the "⏻" on the projector keypad or the remote control.
3. A start up screen will display in approximately 10 seconds and the On/Standby LED will be flashing blue.

**Note:** The first time the projector is turned on, you will be prompted to select the preferred language, projection orientation, and other settings.

### Powering off

1. Turn off the projector by pressing the "⏻" on the projector keypad or the "⏻" on the remote control.
2. The following message will be displayed:

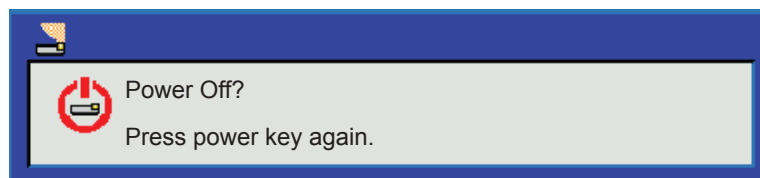

3. Press the "⏻" or the "⏻" button again to confirm, otherwise the message will disappear after 15 seconds. When you press the "⏻" or the "⏻" button for the second time, the projector will shut down.
4. The cooling fans will continue to operate for about 10 seconds for the cooling cycle and the On/Standby LED will flash blue. When the On/Standby LED turns solid red, this indicates the projector has entered standby mode. If you wish to turn the projector back on, you must wait until the cooling cycle has finished and the projector has entered standby mode. When the projector is in standby mode, simply press the "⏻" button again to turn on the projector.
5. Disconnect the power lead from the electrical outlet and the projector.

**Note:** It is not recommended that the projector is turned on immediately, right after a power off procedure.

# USING THE PROJECTOR

## Selecting an input source



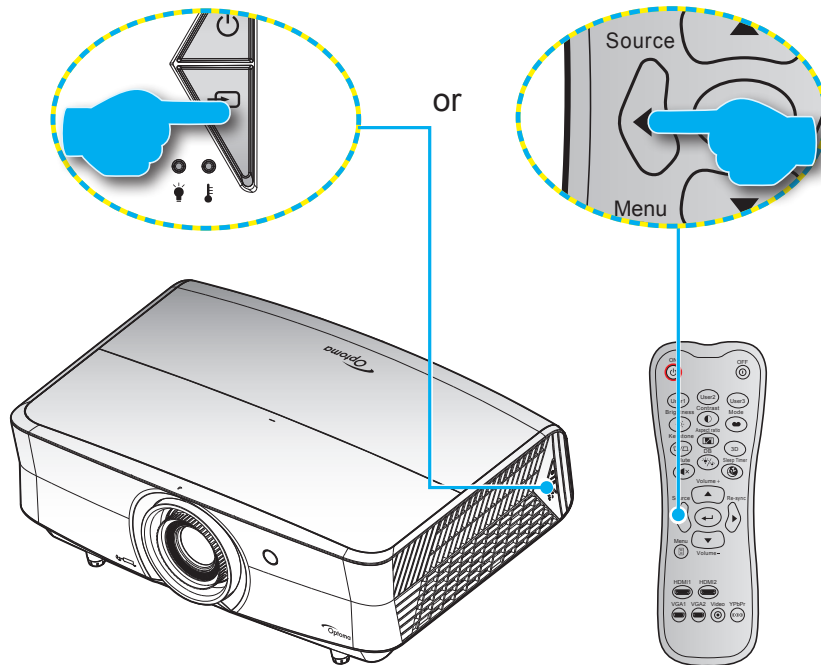











Turn on the connected source that you want to display on the screen, such as computer, notebook, video player, etc. The projector will automatically detect the source. If multiple sources are connected, push the source button on the projector keypad or the remote control to select the desired input.



# USING THE PROJECTOR

## Menu navigation and features

The projector has multilingual on-screen display menus that allow you to make image adjustments and change a variety of settings. The projector will automatically detect the source.

1. To open the OSD menu, press  on the remote control or the projector keyboard.
2. When OSD is displayed, use   keys to select any item in the main menu. While making a selection on a particular page, press  or  key to enter sub menu.
3. Use   keys to select the desired item in the sub menu and then press  or  key to view further settings. Adjust the settings by using   keys.
4. Select the next item to be adjusted in the sub menu and adjust as described above.
5. Press the  or  to confirm, and the screen will return to the main menu.
6. To exit, press the  or  again. The OSD menu will close and the projector will automatically save the new settings.

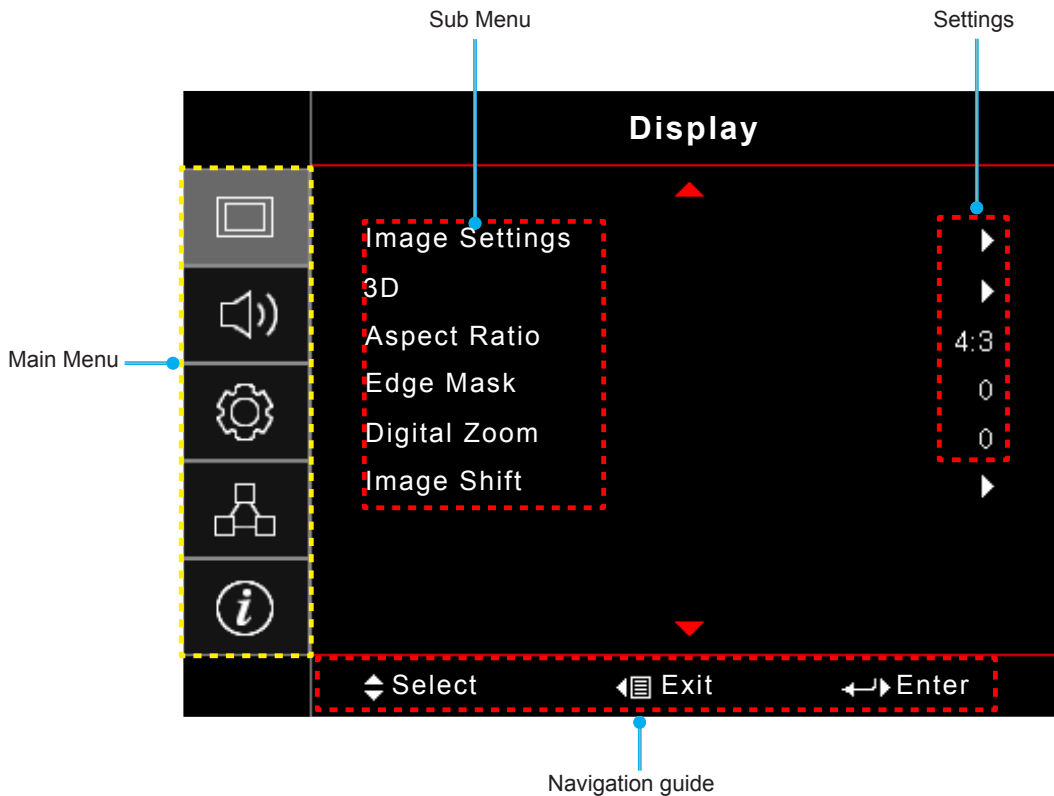



# USING THE PROJECTOR

## OSD Menu tree

Main Menu	Sub Menu	Sub Menu 2	Sub Menu 3	Sub Menu 4	Values		
Display	Image Settings	Display Mode			Cinema		
					HDR		
					HDR SIM.		
					Game		
					Reference		
					Bright		
					User		
					3D		
					ISF Day		
					ISF Night		
				ISF 3D			
			Wall Color			Off [Default]	
						Blackboard	
						Light Yellow	
						Light Green	
						Light Blue	
						Pink	
			Dynamic Range	HDR			Off
							On [Default]
				HDR Picture Mode			Bright
							Standard [Default]
						Film	
						Detail	
				Brightness			-50 ~ 50
				Contrast			-50 ~ 50
				Sharpness			1 ~ 15
				Color			-50 ~ 50
				Tint			-50 ~ 50
			Gamma		Film		
					Video		
					Graphics		
					Standard(2.2)		
					1.8		
					2.0		
					2.4		
				3D			
			Color Settings	BrilliantColor™			1 ~ 10

# USING THE PROJECTOR

Main Menu	Sub Menu	Sub Menu 2	Sub Menu 3	Sub Menu 4	Values
Display	Image Settings	Color Settings	Color Temperature		D55
					D65
					D75
					D83
					D93
					Native
			Color Gamut		Native
					HDTV
					Presentation
					Cinema
					Game
			CMS	Color	R [Default]
					G
					B
					C
					Y
					M
					W
				x offset	-50 ~ 50 [Default:0]
				y offset	-50 ~ 50 [Default:0]
				Brightness	-50 ~ 50 [Default:0]
				Reset	Cancel [Default] Yes
			Exit		
			RGB Gain/Bias	Red Gain	-50 ~ 50
				Green Gain	-50 ~ 50
				Blue Gain	-50 ~ 50
				Red Bias	0 ~ 100
				Green Bias	0 ~ 100
				Blue Bias	0 ~ 100
				Reset	Cancel [Default] Yes
				Exit	
			Color Space [Not HDMI Input]		Auto [Default]
					RGB
					YUV
			Color Space [HDMI Input]		Auto [Default]
					RGB(0~255)
					RGB(16~235)
					YUV

# USING THE PROJECTOR

Main Menu	Sub Menu	Sub Menu 2	Sub Menu 3	Sub Menu 4	Values		
Display	Image Settings	Signal	Automatic		Off		
					On [Default]		
			Frequency		-50 ~ 50 (depends on signal) [Default:0]		
			Phase		0~31 (depends on signal) [Default:0]		
			H. Position		-50 ~ 50 (depends on signal) [Default:0]		
			V. Position		-50 ~ 50 (depends on signal) [Default:0]		
		Exit					
		UltraDetail				Off	
						1	
						2	
						3	
		Brightness Mode				DynamicBlack 1	
						DynamicBlack 2	
						DynamicBlack 3	
						Power (Power = 100%/ 95%/ 90%/ 85%/ 80%/ 75%/ 70%/ 65%/ 60%/ 55%/ 50%)	
		PureEngine	PureContrast			Off	
						On	
			PureColor				Off
							1
							2
							3
							4
							5
			PureMotion				Off
							1
							2
							3
			PureMotion Demo				Off [Default]
							H Split
						V Split	
		Reset					

# USING THE PROJECTOR

Main Menu	Sub Menu	Sub Menu 2	Sub Menu 3	Sub Menu 4	Values		
Display	3D	3D Mode			Off [Default]		
					On		
		3D Sync Invert			Off [Default]		
					On		
	Aspect Ratio				4:3		
					16:9		
					LBX		
					Superwide		
					Native		
					Auto		
	Edge Mask				0 ~ 10 [Default: 0]		
	Digital Zoom				-5 ~ 25 [Default: 0]		
Image Shift	H <input type="checkbox"/>				-100 ~ 100 [Default: 0]		
	V <input checked="" type="checkbox"/>				-100 ~ 100 [Default: 0]		
Audio	Internal Speaker				Auto [Default]		
					Off		
					On		
	Mute					Off [Default]	
					On		
	Volume				0 ~ 10 [Default: 5]		
Setup	Projection				Front  [Default]		
					Rear 		
					Ceiling-top 		
					Rear-top 		
	Filter Settings	Filter Usage Hours				(read only)	
		Optional Filter Installed				Yes	
						No	
		Filter Reminder					Off
							300hr
							500hr [Default]
Filter Reset					800hr		
					1000hr		
					Cancel [Default]		
					Yes		

# USING THE PROJECTOR

Main Menu	Sub Menu	Sub Menu 2	Sub Menu 3	Sub Menu 4	Values	
Setup	Power Settings	Direct Power On			Off [Default]	
					On	
		Auto Power Off (min.)			0 ~ 180 (5 min increments) [Default: 0]	
		Sleep Timer (min.)			0 ~ 990 (30 min increments) [Default: 0]	
			Always On		No [Default]	
					Yes	
	Power Mode (Standby)			Active		
				Eco [Default]		
	Security	Security			Off	
					On	
		Security Timer	Month			
			Day			
			Hour			
	Change Password					
	Test Pattern				Green Grid	
					Magenta Grid	
					White Grid	
					White	
					Off	
	Remote Settings [depends on remote]	IR Function			On	
					Front	
					Back	
					Off	
		User1				Test Pattern
						LAN
						CMS
						Color Temp
						Gamma
						Auto Source
						Projection
						Zoom
						MHL
					Dynamic Range [Default]	
					Info	
					PureEngine	

# USING THE PROJECTOR

Main Menu	Sub Menu	Sub Menu 2	Sub Menu 3	Sub Menu 4	Values		
Setup	Remote Settings [depends on remote]	User2			Test Pattern		
					LAN		
					CMS		
					Color Temp		
					Gamma		
					Auto Source		
					Projection		
					Zoom		
					MHL [Default]		
					Dynamic Range		
				Info			
				PureEngine			
			User3			Test Pattern	
						LAN	
						CMS	
						Color Temp	
						Gamma	
						Auto Source	
					Projection		
					Zoom		
			User3			MHL	
						Dynamic Range	
						Info [Default]	
						PureEngine	
			Projector ID				00 ~ 99
			12V Trigger	12V Trigger			On
							Off
			Options	Language			English [Default]
							Deutsch
							Français
						Italiano	
						Español	
					Português		
					簡体中文		
					日本語		
					한국어		
				Русский			

# USING THE PROJECTOR

Main Menu	Sub Menu	Sub Menu 2	Sub Menu 3	Sub Menu 4	Values
Setup	Options	Menu Settings	Menu Location		Top left 
					Top right 
					Center  [Default]
					Bottom left 
					Bottom right 
			Menu Timer		Off
					5sec
					10sec [Default]
			Auto Source		Off [Default]
			Input Source		On
				HDMI1	
				HDMI2/MHL	
		High Altitude		VGA	
				Off [Default]	
		Display Mode Lock		On	
				Off [Default]	
		Keypad Lock		On	
				Off [Default]	
		Information Hide		On	
				Off [Default]	
		Logo		Default [Default]	
				Neutral	
		Background Color		None [Default]	
				Blue	
				Red	
				Green	
		HDMI 1 EQ		Gray	
		HDMI 2 EQ		1 ~ 7 [Default: 4]	
	Reset	Reset OSD		1 ~ 7 [Default: 4]	
				Cancel [Default]	
		Reset to Default		Yes	
				Cancel [Default]	
Network	LAN	Network Status		(read only)	
		MAC Address		(read only)	
		DHCP		Off [Default]	
				On	
		IP Address		192.168.0.100 [Default]	
		Subnet Mask		255.255.255.0 [Default]	
		Gateway		192.168.0.254 [Default]	
		DNS		192.168.0.51 [Default]	
Reset					

# USING THE PROJECTOR

Main Menu	Sub Menu	Sub Menu 2	Sub Menu 3	Sub Menu 4	Values
Network	Control	Crestron			Off
					On [Default] <b>NOTE: Port 41794</b>
		Extron			Off
					On [Default] <b>NOTE: Port 2023</b>
		PJ Link			Off
					On [Default] <b>NOTE: Port 4352</b>
		AMX Device Discovery			Off
					On [Default] <b>NOTE: Port 9131</b>
Telnet			Off		
			On [Default] <b>NOTE: Port 23</b>		
HTTP			Off		
			On [Default] <b>NOTE: Port 80</b>		
Information	Regulatory				
	Serial Number				
	Source				
	Resolution				00x00
	Refresh Rate				0.00Hz
	Color Depth				
	Color Format				
	Display Mode				
	Power Mode (Standby)				
	Light Source Hours				
	Network Status				
	IP Address				
	Projector ID				00 ~ 99
	Filter Usage Hours				
	Brightness Mode				
	FW Version	System			
LAN					
MCU					
EDID					



# USING THE PROJECTOR

## Display menu

### Display image settings menu

#### Display Mode

There are many factory presets optimized for various types of images.

- **Cinema:** Provides the best colours for watching movies.
- **HDR:** Decodes and displays High Dynamic Range (HDR) content for the deepest blacks, brightest whites, and vivid cinematic color using REC.2020 color gamut. This mode will be automatically enabled if HDR is set to ON (and HDR Content is sent to projector – 4K UHD Blu-ray, 1080p/4K UHD HDR Games, 4K UHD Streaming Video). While HDR mode is active, other display modes (Cinema, Reference, etc.) cannot be selected as HDR delivers color that is highly accurate, exceeding the color performance of the other display modes.
- **HDR SIM.:** Enhances non-HDR content with simulated High Dynamic Range (HDR). Choose this mode to enhance gamma, contrast, and color saturation for non-HDR content (720p and 1080p Broadcast/Cable TV, 1080p Blu-ray, non-HDR Games, etc). This mode can ONLY be used with non-HDR content.
- **Game:** Select this mode to increase the brightness and response time level for enjoying video games.
- **Reference:** This mode is intended to reproduce as close as possible the image the way the movie director intended. Color, color temperature, brightness, contrast and gamma settings are all configured to standard reference levels. Select this mode to watch a video.
- **Bright:** Maximum brightness from PC input.
- **User:** Memorize user's settings.
- **3D:** To experience the 3D effect, you need to have 3D glasses, make sure your PC/portable device has a 120 Hz signal output quad buffered graphics card and have a 3D Player installed.
- **ISF Day:** Optimize the image with the ISF Day mode to be perfectly calibrated and high picture quality.
- **ISF Night:** Optimize the image with the ISF Night mode to be perfectly calibrated and high picture quality.
- **ISF 3D:** Optimize the image with the ISF 3D mode to be perfectly calibrated and high picture quality.

**Note:** For access and calibration of ISF daytime and night viewing modes, please contact your local dealer.

#### Wall Color

Use this function to obtain an optimized screen image according to the wall color. Select between off, blackboard, light yellow, light green, light blue, pink, and gray.

#### Dynamic Range

Configure the High Dynamic Range (HDR) setting and its effect when displaying video from 4K Blu-ray players and streaming devices.

- **HDR**
  - Off: Turn off HDR Processing. When set to Off, the projector will NOT decode HDR content.
  - On: Turn on HDR Processing. When set to On, the projector will decode ALL HDR content (4K UHD Blu-ray, 1080p/4K UHD HDR Games, 4K UHD Streaming Video).
- **HDR Picture Mode**
  - Bright: Choose this mode for brighter more saturated colors.
  - Standard: Choose this mode for natural looking colors with a balance of warm and cool tones.
  - Film: Choose this mode for improved detail and image sharpness.
  - Detail: Choose this mode for improved detail and image sharpness in dark scenes.

# USING THE PROJECTOR

- **HDR Compatibility**
  - The projector is compatible with HDR10 metadata. The projector does not support Dolby Vision HDR metadata.

## **Brightness**

Adjust the brightness of the image.

## **Contrast**

The contrast controls the degree of difference between the lightest and darkest parts of the picture.

## **Sharpness**

Adjust the sharpness of the image.

## **Color**

Adjust a video image from black and white to fully saturated color.

## **Tint**

Adjust the color balance of red and green.

## **Gamma**

Set up gamma curve type. After the initial setup and fine tuning is completed, utilize the Gamma Adjustment steps to optimize your image output.

- **Film:** For home theater.
- **Video:** For video or TV source.
- **Graphics:** For PC / Photo source.
- **Standard(2.2):** For standardized setting.
- **1.8 / 2.0 / 2.4:** For specific PC / Photo source.
- **3D:** For 3D source.

**Note:** 3D gamma option is visible and available only for 3D sources.

## **Color Settings**

Configure the color settings.

- **BrilliantColor™:** This adjustable item utilizes a new color-processing algorithm and enhancements to enable higher brightness while providing true, more vibrant colors in picture.
- **Color Temperature:** Select a color temperature from D55, D65, D75, D83, D93, or Native.
- **Color Gamut:** Select an appropriate color gamut from Native, HDTV, Presentation, Cinema, or Game.
- **CMS (Color Management System):** Select one of the colors (R/G/B/C/Y/M/W) to adjust its x/y offset and brightness.
  - Color: Select between red (R), green (G), blue (B), cyan (C), yellow (Y), magenta (M), and white (W) color.
  - x offset: Adjust the x offset value of the selected color.
  - y offset: Adjust the y offset value of the selected color.
  - Brightness: Adjust the brightness value of the selected color.
  - Reset: Return the factory default settings for color adjustments.
  - Exit: Exit the “CMS” menu.
- **RGB Gain/Bias:** This settings allows to configure the brightness (gain) and contrast (bias) of an image.

# USING THE PROJECTOR

- **Reset:** Return the factory default settings for RGB gain/bias.
- **Exit:** Exit the “RGB Gain/Bias” menu.
- **Color Space (non-HDMI input only):** Select an appropriate color matrix type from the following: AUTO, RGB, or YUV.
- **Color Space (HDMI input only):** select an appropriate color matrix type from the following: Auto, RGB(0-255), RGB(16-235), and YUV.

## **Signal**

Adjust the signal options.

- **Automatic:** Configure automatically the signal (the frequency and phase items are grayed out). If automatic is disabled, the frequency and phase items will appear for tuning and saving the settings.
- **Frequency:** Change the display data frequency to match the frequency of your computer’s graphic card. Use this function only if the image appears to flicker vertically.
- **Phase:** Synchronize the signal timing of the display with the graphic card. If the image appears to be unstable or flickers, use this function to correct it.
- **H. Position:** Adjust the horizontal positioning of the image.
- **V. Position:** Adjust the vertical positioning of the image.
- **Exit:** Exit the “Signal” menu.

**Note:** *This menu is only available if the input source is RGB/Component.*

## **UltraDetail**

Adjust the edges of the projected image in order to provide more perceived details.

## **Brightness Mode**

Adjust the brightness mode settings.

- **DynamicBlack 1/ DynamicBlack 2/ DynamicBlack 3:** Use to automatically adjust the picture brightness in order to give optimum contrast performance.
- **Power:** Choose the power percentage for brightness mode.

## **PureEngine**

Adjust the PureEngine parameters.

- **PureContrast:** Use to automatically optimize the brightness of the display during dark / light movie scenes to be shown in incredible detail.
- **PureColor:** Use to significantly increase the image’s vividness.
- **PureMotion:** Use to preserve a natural motion of the displayed image.
- **PureMotion Demo:** This feature enables you to see the difference in the image quality between the raw unprocessed image and the image processed as processed by the PureMotion. Use this mode to check the adjustments that you make to the PureMotion settings.

**Note:** *This menu is only available for certain models.*

## **Reset**

Return the factory default settings for color settings.

# USING THE PROJECTOR

## Display 3D menu

### Note:

- This projector is a 3D ready projector with DLP-Link 3D solution.
- Please make sure your 3D glasses are use for DLP-Link 3D before enjoy your video.
- This projector supports frame sequential (page-flip) 3D via HDMI1/HDMI2/VGA ports.
- To enable 3D mode, the input frame rate should be set to 60Hz only, lower or higher frame rate is not supported.
- To reach the best performance, resolution 1920x1080 is recommended, please be noted that 4K (3840x2160) resolution is not supported in 3D mode.

### 3D Mode

Switch the 3D mode on or off.

### 3D Sync Invert

- Press the “On” to invert left and right frame contents.
- Press the “Off” for default frame contents.

## Display aspect ratio menu

### Aspect Ratio

Select the aspect ratio of the displayed image between the following options:

- **4:3:** This format is for 4:3 input sources.
- **16:9:** This format is for 16:9 input sources, like HDTV and DVD enhanced for Wide screen TV.
- **LBX:** This format is for non-16x9, letterbox source and if you use external 16x9 lens to display 2.35:1 aspect ratio in full resolution.
- **Superwide:** Use this special 2.0:1 aspect ratio to display both 16:9 and 2.35:1 aspect ratio movies without black bars at the top and bottom of the screen.
- **Native:** This format displays the original image without any scaling.
- **Auto:** Automatically selects the appropriate display format.

### Note:

- *Detailed informations about LBX mode:*
  - *Some Letter-Box Format DVDs are not enhanced for 16x9 TVs. In this situation, the image will not look right when displaying image in 16:9 mode. In this situation, please try to use the 4:3 mode to view the DVD. If the content is not 4:3, there will be black bars around the image in 16:9 display. For this type of content, you can use LBX mode to fill the image on the 16:9 display.*
  - *If you use an external anamorphic lens, this LBX mode also allows you to watch a 2.35:1 content (include Anamorphic DVD and HDTV film source) that supports anamorphic wide is enhanced for 16x9 Display in a wide 2.35:1 image. In this case, there are no black bars. Light source power and vertical resolution are fully utilized.*
- *To use the superwide format, do the following:*
  - a) *Set the screen aspect ratio to 2.0:1.*
  - b) *Select “Superwide” format.*
  - c) *Align the projector image correctly on the screen.*

# USING THE PROJECTOR

## 4K UHD scaling table:

16 : 9 screen	480i/p	576i/p	720p	1080i/p	2160p
<b>4x3</b>	Scale to 2880 x 2160.				
<b>16x9</b>	Scale to 3840 x 2160.				
<b>LBX</b>	Get the central 3840 x 1620 image, and then scale to 3840 x 2160 for display.				
<b>Native mode</b>	1:1 mapping centered. No scaling will be made; the displayed resolution depends on input source.				
<b>Auto</b>	-If source is 4:3, the screen type will be scaled to 2880 x 2160. -If source is 16:9, the screen type will be scaled to 3840 x 2160. -If source is 15:9, the screen type will be scaled to 3600 x 2160. -If source is 16:10, the screen type will be scaled to 3456 x 2160.				

## Auto mapping rule:

	Input resolution		Auto/Scale	
	H-resolution	V-resolution	3840	2160
<b>4:3</b>	640	480	2880	2160
	800	600	2880	2160
	1024	768	2880	2160
	1280	1024	2880	2160
	1400	1050	2880	2160
	1600	1200	2880	2160
<b>Wide Laptop</b>	1280	720	3840	2160
	1280	768	3600	2160
	1280	800	3456	2160
<b>SDTV</b>	720	576	2700	2160
	720	480	3240	2160
<b>HDTV</b>	1280	720	3840	2160
	1920	1080	3840	2160

## Display edge mask menu

### Edge Mask

Use this function to remove the video encoding noise on the edge of video source.

## Display digital zoom menu

### Digital Zoom

Use to reduce or magnify an image on the projection screen.

## Display image shift menu

### Image Shift

Adjust the projected image position horizontally (H) or vertically (V).

# USING THE PROJECTOR

## *Audio menu*

### Audio internal speaker menu

#### Internal Speaker

Use this option to turn on or off the internal speaker.

- **Auto:** Choose “Auto” to automatically turn off the internal speaker when an external speaker is connected to the projector.
- **Off:** Choose “Off” to turn off the internal speaker.
- **On:** Choose “On” to turn on the internal speaker.

### Audio mute menu

#### Mute

Use this option to temporarily turn off the sound.

- **On:** Choose “On” to turn mute on.
- **Off:** Choose “Off” to turn mute off.

**Note:** “Mute” function affects both internal and external speaker volume.

### Audio volume menu

#### Volume

Adjust the volume level.

## *Setup menu*

### Setup projection menu

#### Projection

Select the preferred projection between front, rear, ceiling-top, and rear-top.

### Setup filter settings menu

#### Filter Usage Hours

Display the filter time.

#### Optional Filter Installed

Set the warning message setting.

- **Yes:** Display warning message after 500 hours of use.

**Note:** “Filter Usage Hours / Filter Reminder / Filter Reset” will only appear when “Optional Filter Installed” is “Yes”.

- **No:** Turn off warning message.

#### Filter Reminder

Choose this function to show or hide the warning message when the changing filter message is displayed. The available options include 300hr, 500hr, 800hr, and 1000hr.

# USING THE PROJECTOR

## Filter Reset

Reset the dust filter counter after replacing or cleaning the dust filter.

## Setup power settings menu

### Direct Power On

Choose “On” to activate Direct Power mode. The projector will automatically power on when AC power is supplied, without pressing the “Power” key on the projector keypad or on the remote control.

### Auto Power Off (min.)

Sets the countdown timer interval. The countdown timer will start, when there is no signal being sent to the projector. The projector will automatically power off when the countdown has finished (in minutes).

### Sleep Timer (min.)

Configure the sleep timer.

- **Sleep Timer (min.):** Sets the countdown timer interval. The countdown timer will start, with or without a signal being sent to the projector. The projector will automatically power off when the countdown has finished (in minutes).  
**Note:** *The Sleep Timer is reset every time when the projector is powered off.*
- **Always On:** Check to set the sleep timer always on.

### Power Mode (Standby)

Set the power mode setting.

- **Active:** Choose “Active” to return to normal standby.
- **Eco:** Choose “Eco.” to save power dissipation further < 0.5W.

## Setup security menu

### Security

Enable this function to prompt for a password before using the projector.

- **On:** Choose “On” to use security verification when the turning on the projector.
- **Off:** Choose “Off” to be able to switch on the projector without password verification.

### Security Timer

Can be select the time (Month/Day/Hour) function to set the number of hours the projector can be used. Once this time has elapsed you will be requested to enter your password again.

### Change Password

Use to set or modify the password that is prompted when turning the projector on.

## Setup test pattern menu

### Test Pattern

Select the test pattern from green grid, magenta grid, white grid, white, or disable this function (off).

# USING THE PROJECTOR

## Setup remote settings menu

### IR Function

Set the IR function setting.

- **On:** Choose “On”, the projector can be operated by the remote control from top and front IR receivers.
- **Front:** Choose “Front”, the projector can be operated by the remote control from the front IR receiver.
- **Back:** Choose “Back”, the projector can be operated by the remote control from the rear IR receiver.
- **Off:** Choose “Off”, the projector can’t be operated by the remote control. By selecting “Off”, you will be able to use the Keypad keys.

### User1/ User2/ User3

Assign the default function for User1, User2, or User3 between Test Pattern, LAN, CMS, Color Temp, Gamma, Auto Source, Projection, Zoom, MHL, Dynamic Range, Info, or PureEngine.

## Setup projector ID menu

### Projector ID

ID definition can be set up by menu (range 0-99), and allow user control an individual projector by using RS232 command.

## Setup 12V trigger menu

### 12V Trigger

Use this function to enable or disable the trigger.

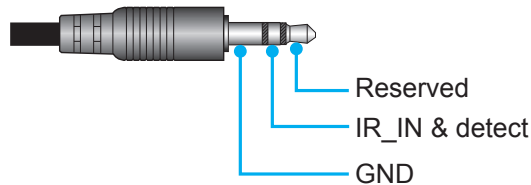

- **Off:** Choose “Off” to disable the trigger.
- **On:** Choose “On” to enable the trigger.

## Setup options menu

### Language

Select the multilingual OSD menu between English, German, French, Italian, Spanish, Portuguese, Simplified Chinese, Japanese, Korean, and Russian.

### Menu Settings

Set the menu location on the screen and configure menu timer settings.

- **Menu Location:** Select the menu location on the display screen.
- **Menu Timer:** Set the duration where the OSD menu stays visible on the screen.

### Auto Source

Choose this option to let the projector automatically find an available input source.

### Input Source

Select the input source between HDMI1, HDMI2/MHL, and VGA.

### High Altitude

When “On” is selected, the fans will spin faster. This feature is useful in high altitude areas where the air is thin.



# USING THE PROJECTOR

## Display Mode Lock

Choose “On” or “Off” to lock or unlock adjusting display mode settings.

## Keypad Lock

When the keypad lock function is “On”, the Keypad will be locked. However, the projector can be operated by the remote control. By selecting “Off”, you will be able to reuse the Keypad.

## Information Hide

Enable this function to hide the information message.

- **Off:** Choose “On” to hide the info message.
- **On:** Choose “Off” to show the “searching” message.

## Logo

Use this function to set the desired startup screen. If changes are made, they will take effect the next time the projector is powered on.

- **Default:** The default startup screen.
- **Neutral:** Logo is not displayed on startup screen.

## Background Color

Use this function to display a blue, red, green, gray color, or none when no signal is available.

## HDMI 1 EQ

Set the HDMI port EQ value for HDMI1.

## HDMI 2 EQ

Set the HDMI port EQ value for HDMI2/MHL.

### **Note:**

- *HDMI EQ analyses the signal data and eliminates distortion due to signal loss when using long HDMI cables. The HDMI receiver also includes a timing adjustment circuit that removes timing jitter, restoring the HDMI signal to optimal transmission levels.*
- *3840x2160@60Hz suggests using the HDMI cable under 5 meters.*
- *3840x2160@30Hz/25Hz/24Hz suggests using the HDMI cable under 15 meters.*

## Setup reset OSD menu

### Reset OSD

Return the factory default settings for OSD menu settings.

### Reset to Default

Return the factory default settings for all settings.

## *Network menu*

## Network LAN menu

### Network Status

Display the network connection status (read-only).

### MAC Address

Display the MAC address (read-only).

# USING THE PROJECTOR

## DHCP

Use this option to enable or disable the DHCP function.

- **Off:** To assign IP, subnet mask, gateway, and DNS configuration manually.
- **On:** Projector will obtain an IP address automatically from your network.

**Note:** Exiting OSD will automatically apply the entered values.

## IP Address

Display the IP address.

## Subnet Mask

Display subnet mask number.

## Gateway

Display the default gateway of the network connected to the projector.

## DNS

Display the DNS number.

## How to use web browser to control your projector

1. Turn “On” the DHCP option on projector to allow a DHCP server to automatically assign an IP address.
2. Open the web browser in your PC and type in the projector’s IP address (“Network > LAN > IP Address”).
3. Enter the user name and password, and click “Login”.  
The projector’s configuration web interface opens.

**Note:**

- The default user name and password is “admin”.
- The steps in this section is based on Windows 7 operating system.

## Making a direct connection from your computer to the projector\*

1. Turn “Off” the DHCP option on the projector.
2. Configure the IP address, Subnet Mask, Gateway, and DNS on projector (“Network > LAN”).
3. Open **Network and Sharing Center** page on your PC, and assign the identical network parameters to your PC as set on projector. Click “OK” to save the parameters.

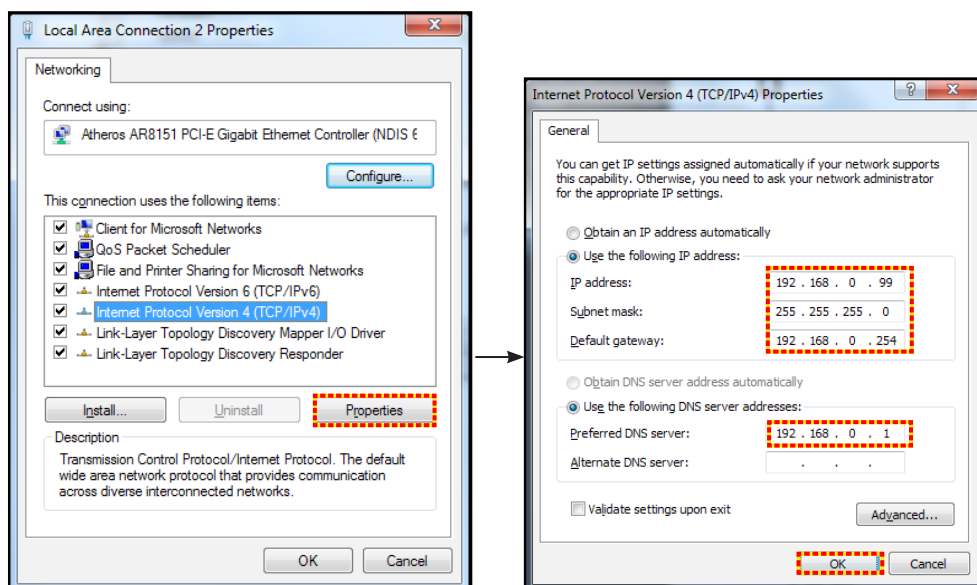

4. Open the web browser on your PC and type in to the URL field the IP address, assigned in step 3. Then press “Enter” key.

# USING THE PROJECTOR

## Reset

Reset all values for LAN parameters.

## Network control menu

### Crestron

Use this function to select the network function (port: 41794).

For more information, please visit <http://www.crestron.com> and [www.crestron.com/getroomview](http://www.crestron.com/getroomview).

### Extron

Use this function to select the network function (port: 2023).

### PJ Link

Use this function to select the network function (port: 4352).

### AMX Device Discovery

Use this function to select the network function (port: 9131).

### Telnet

Use this function to select the network function (port: 23).

### HTTP

Use this function to select the network function (port: 80).

## Setup network control settings menu

### LAN\_RJ45 function

For simplicity and ease of operation, the projector provides diverse networking and remote management features. The LAN / RJ45 function of the projector through a network, such as remotely manage: Power On / Off, brightness, and contrast settings. Also, you can view the projector status information, such as: Video- Source, Sound-Mute, etc.

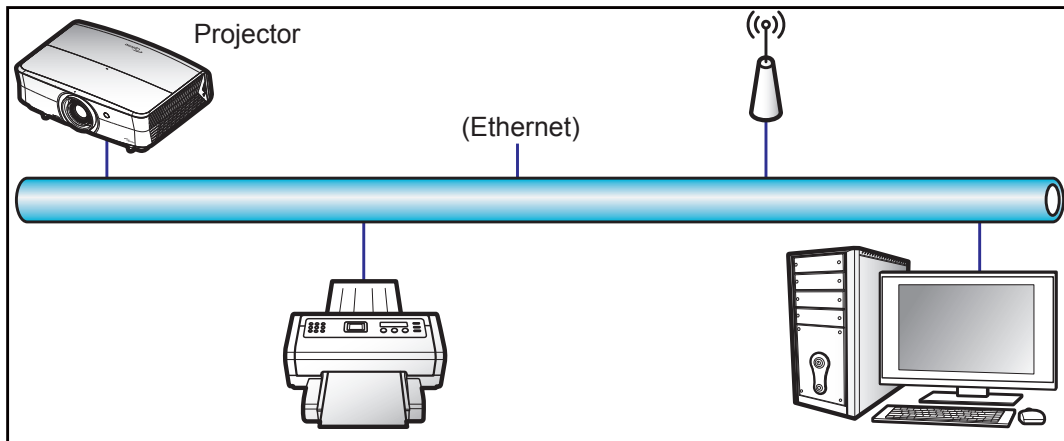

# USING THE PROJECTOR

## Wired LAN terminal functionalities

This projector can be controlled by using a PC (laptop) or other external device via LAN / RJ45 port and compatible with Crestron / Extron / AMX (Device -Discovery) / PJLink.

- Crestron is a registered trademark of Crestron Electronics, Inc. of the United States.
- Extron is a registered trademark of Extron Electronics, Inc. of the United States.
- AMX is a registered trademark of AMX LLC of the United States.
- PJLink applied for trademark and logo registration in Japan, the United States of America, and other countries by JBMIA.

The projector is supported by the specified commands of the Crestron Electronics controller and related software, for example RoomView®.

<http://www.crestron.com/>

This projector is compliant to support Extron device(s) for reference.

<http://www.extron.com/>

This projector is supported by AMX ( Device Discovery ).

<http://www.amx.com/>

This projector supports all commands of PJLink Class1 (Version 1.00).

<http://pjlink.jbmia.or.jp/english/>

For more detailed information about the various types of external devices which can be connected to the LAN / RJ45 port and remote control the projector, as well as the supported commands for these external devices, please contact the Support-Service directly.

## LAN RJ45

1. Connect an RJ45 cable to RJ45 ports on the projector and the PC (laptop).

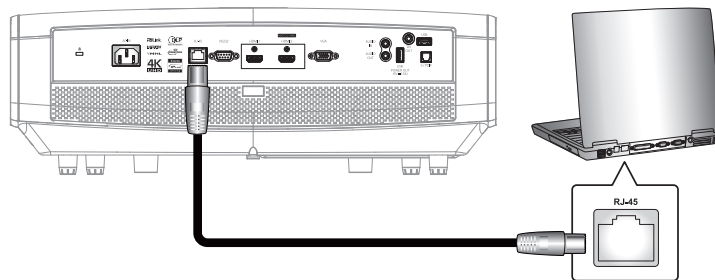

2. On the PC (Laptop), select **Start > Control Panel > Network Connections**.

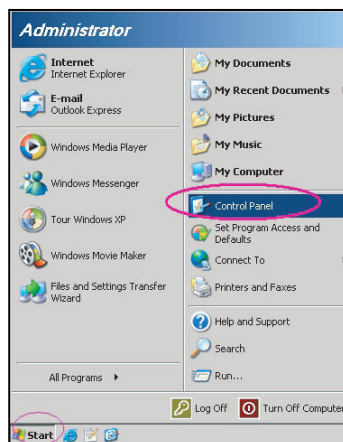

# USING THE PROJECTOR

3. Right-click on the **Local Area Connection**, and select **Property**.

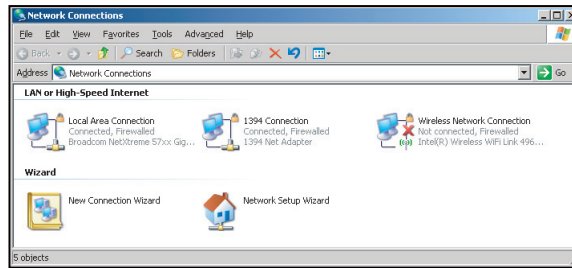

4. In the **Properties** window, select the **General** tab, and select **Internet Protocol (TCP / IP)**.

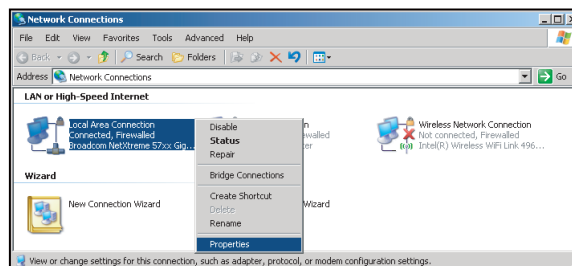

5. Click "Properties".

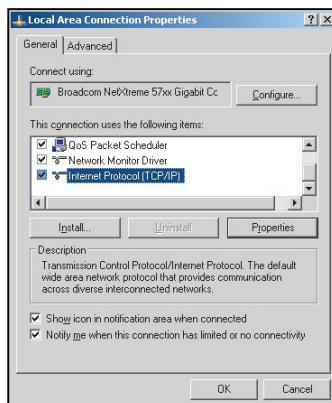

6. Type in the IP address and Subnet mask, then press "OK".

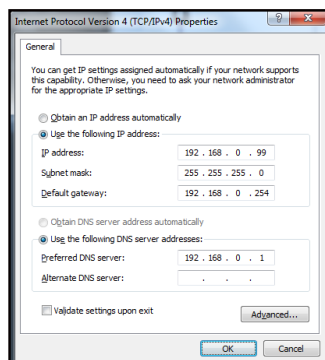

# USING THE PROJECTOR

7. Press the “Menu” button on the projector.
8. Open on projector **Network > LAN**.
9. Enter the following connection parameters:
  - DHCP: Off
  - IP Address: 192.168.0.100
  - Subnet Mask: 255.255.255.0
  - Gateway: 192.168.0.254
  - DNS: 192.168.0.51
10. Press “Enter” to confirm settings.
11. Open a web browser, for example Microsoft Internet Explorer with Adobe Flash Player 9.0 or higher installed.
12. In the Address bar, input the projector’s IP address: 192.168.0.100.



13. Press “Enter”.  
The projector is setup for remote management. The LAN / RJ45 function displays as follows:

Information page

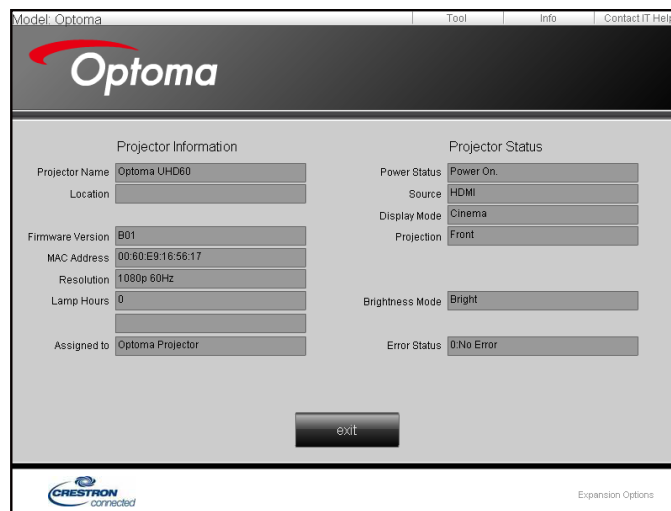

Main page



# USING THE PROJECTOR

Tool page

Contact IT helpdesk

## RS232 by Telnet Function

There is alternative RS232 command control way, in projector so called “RS232 by TELNET” for LAN / RJ45 interface.

### Quick Start-Guide for “RS232 by Telnet”

- Check and get the IP address on OSD of the projector.
- Make sure that the PC / laptop can access the web-page of the projector.
- Make sure that “Windows Firewall” setting is set disabled in case of “TELNET” function filtering out by PC / laptop.

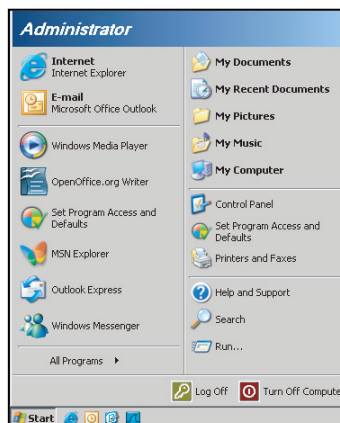

# USING THE PROJECTOR

1. Select **Start > All Programs.> Accessories > Command Prompt.**

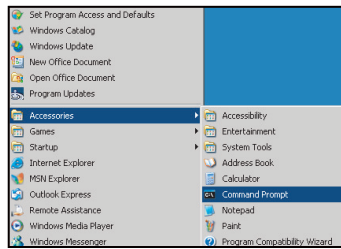

2. Input the command format as follows:
  - telnet ttt.xxx.yyy.zzz 23 (“Enter” key pressed)
  - (ttt.xxx.yyy.zzz: IP-Address of the projector)
3. If Telnet-Connection ready, and user can have RS232 command input, then “Enter” key pressed, the RS232 command will be workable.

## Specification for “RS232 by TELNET”:

1. Telnet: TCP.
2. Telnet port: 23 (for more detail, kindly please get contact with the service agent or team).
3. Telnet utility: Windows “TELNET.exe” (console mode).
4. Disconnection for RS232-by-Telnet control normally: Close
5. Windows Telnet utility directly after TELNET connection ready.
  - Limitation 1 for Telnet-Control: there is less than 50 bytes for successive network payload for Telnet-Control application.
  - Limitation 2 for Telnet-Control: there is less than 26 bytes for one complete RS232 command for Telnet-Control.
  - Limitation 3 for Telnet-Control: Minimum delay for next RS232 command must be more than 200 (ms).



# USING THE PROJECTOR

## *Info menu*

### **Info menu**

View the projector information as listed below:

- Regulatory
- Serial Number
- Source
- Resolution
- Refresh Rate
- Color Depth
- Color Format
- Display Mode
- Power Mode (Standby)
- Light Source Hours
- Network Status
- IP Address
- Projector ID
- Filter Usage Hours
- Brightness Mode
- FW Version

# MAINTENANCE

## Installing and cleaning the dust filter

### Installing the dust filter

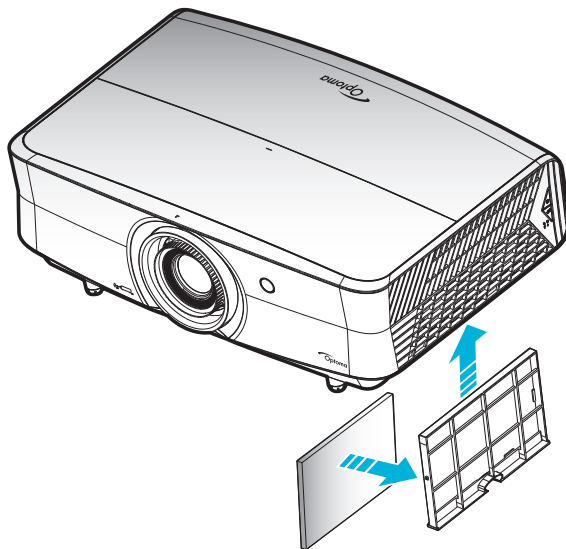

**Note:** Dust filters are only required/supplied in the selected regions with excessive dust.

### Cleaning the dust filter

We recommend you to clean the dust filter every three months. Clean it more often if the projector is used in a dusty environment.

Procedure:

1. Switch off the power to the projector by pressing the "⏻" button on the projector keypad or the "Ⓛ" button on the remote control.
2. Disconnect the power cord.
3. Pull the dust filter compartment downwards to remove it out from the bottom of the projector. **1**
4. Carefully remove the air filter. Then clean or replace the dust filter. **2**
5. To install the dust filter, reverse the previous steps.

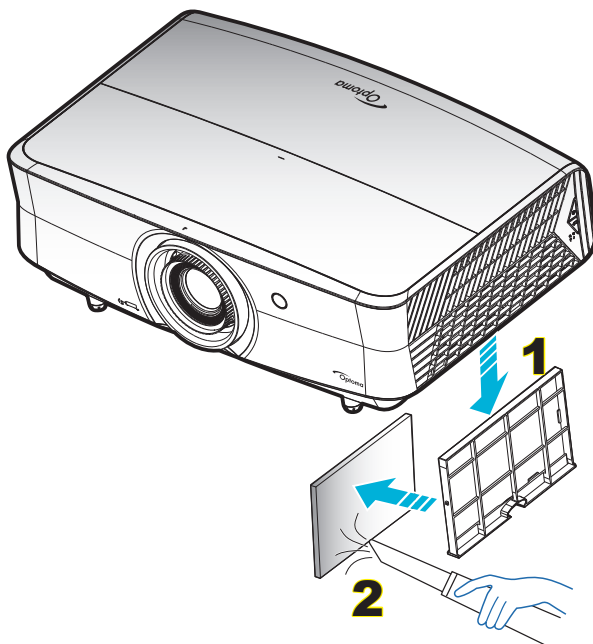

# ADDITIONAL INFORMATION

## Compatible resolutions

### Digital (HDMI 1.4)

Native resolution: 1920 x 1080 @ 60Hz

Established Timing	Standard Timing	Descriptor Timing	Supported Video Mode	Detail Timing
720 x 400 @ 70Hz	1280 x 720 @ 60Hz	1920 x 1080 @ 60Hz (default)	720 x 480i @ 60Hz 16:9	1920 x 1080p @ 60Hz
640 x 480 @ 60Hz	1280 x 800 @ 60Hz		720 x 480p @ 60Hz 4:3	
640 x 480 @ 67Hz	1280 x 1024 @ 60Hz		720 x 480p @ 60Hz 16:9	
640 x 480 @ 72Hz	1920 x 1200 @ 60Hz (reduced)		720 x 576i @ 50Hz 16:9	
640 x 480 @ 75Hz	1366 x 768 @ 60Hz		720 x 576p @ 50Hz 4:3	
800 x 600 @ 56Hz			720 x 576p @ 50Hz 16:9	
800 x 600 @ 60Hz			1280 x 720p @ 60Hz 16:9	
800 x 600 @ 72Hz			1280 x 720p @ 50Hz 16:9	
800 x 600 @ 75Hz			1920 x 1080i @ 60Hz 16:9	
832 x 624 @ 75Hz			1920 x 1080i @ 50Hz 16:9	
1024 x 768 @ 60Hz			1920 x 1080p @ 60Hz 16:9	
1024 x 768 @ 70Hz			1920 x 1080p @ 50Hz 16:9	
1024 x 768 @ 75Hz			1920 x 1080p @ 24Hz 16:9	
1280 x 1024 @ 75Hz			3840 x 2160 @ 24Hz	
1152 x 870 @ 75Hz			3840 x 2160 @ 25Hz	
			3840 x 2160 @ 30Hz	
			4096 x 2160 @ 24Hz	

### Digital (HDMI 2.0)

Native resolution: 1920 x 1080 @ 60Hz

B0 / Established Timing	B0 / Standard Timing	B1 / Video Mode	B1 / Detail Timing
720 x 400 @ 70Hz	1280 x 720 @ 60Hz	720 x 480i @ 60Hz 16:9	1920 x 1080p @ 60Hz
640 x 480 @ 60Hz	1280 x 800 @ 60Hz	720 x 480p @ 60Hz 4:3	
640 x 480 @ 67Hz	1280 x 1024 @ 60Hz	720 x 480p @ 60Hz 16:9	
640 x 480 @ 72Hz	1920 x 1200 @ 60Hz (reduced)	720 x 576i @ 50Hz 16:9	
640 x 480 @ 75Hz	1366 x 768 @ 60Hz	720 x 576p @ 50Hz 4:3	
800 x 600 @ 56Hz		720 x 576p @ 50Hz 16:9	
800 x 600 @ 60Hz		1280 x 720p @ 60Hz 16:9	
800 x 600 @ 72Hz		1280 x 720p @ 50Hz 16:9	
800 x 600 @ 75Hz		1920 x 1080i @ 60Hz 16:9	
832 x 624 @ 75Hz		1920 x 1080i @ 50Hz 16:9	
1024 x 768 @ 60Hz		1920 x 1080p @ 60Hz 16:9	
1024 x 768 @ 70Hz		1920 x 1080p @ 50Hz 16:9	
1024 x 768 @ 75Hz		1920 x 1080p @ 24Hz 16:9	
1280 x 1024 @ 75Hz		3840 x 2160 @ 24Hz	
1152 x 870 @ 75Hz		3840 x 2160 @ 25Hz	
		3840 x 2160 @ 30Hz	
		3840 x 2160 @ 50Hz	
		3840 x 2160 @ 60Hz	
		4096 x 2160 @ 24Hz	
		4096 x 2160 @ 25Hz	

# ADDITIONAL INFORMATION

B0 / Established Timing	B0 / Standard Timing	B1 / Video Mode	B1 / Detail Timing
		4096 x 2160 @ 30Hz	
		4096 x 2160 @ 50Hz	
		4096 x 2160 @ 60Hz	

**Note:** Support 1920 x 1080 @ 50Hz.

## Analog

Native resolution: 1920 x 1080 @ 60Hz

B0 / Established Timing	B0 / Standard Timing	B0 / Detail Timing	B1 / Detail Timing
720 x 400 @ 70Hz	1280 x 720 @ 60Hz	1920 x 1080 @ 60Hz (default)	1366 x 768 @ 60Hz
640 x 480 @ 60Hz	1280 x 800 @ 60Hz		
640 x 480 @ 67Hz	1280 x 1024 @ 60Hz		
640 x 480 @ 72Hz	1400 x 1050 @ 60Hz		
640 x 480 @ 75Hz	1600 x 1200 @ 60Hz		
800 x 600 @ 56Hz			
800 x 600 @ 60Hz			
800 x 600 @ 72Hz			
800 x 600 @ 75Hz			
832 x 624 @ 75Hz			
1024 x 768 @ 60Hz			
1024 x 768 @ 70Hz			
1024 x 768 @ 75Hz			
1280 x 1024 @ 75Hz			
1152 x 870 @ 75Hz			

**Note:** Support 1920 x 1080 @ 50Hz.

## Image size and projection distance

(image size and distance in meters and feet)

Diagonal length (inch) size of 16:9 Screen	Screen Size W x H				Projection Distance (D)				Min Offset (Hd)		Max Offset (Hd)	
	(m)		(feet)		(m)		(feet)		(m)	(feet)	(m)	(feet)
	Width	Height	Width	Height	Wide	Tele	Wide	Tele				
30.00	0.66	0.37	2.18	1.23	0.92	1.47	3.02	4.82	0.00	0.00	0.06	0.18
40.00	0.89	0.50	2.91	1.63	1.23	1.97	4.04	6.46	0.00	0.00	0.07	0.25
60.00	1.33	0.75	4.36	2.45	1.85	2.95	6.07	9.68	0.00	0.00	0.11	0.37
70.00	1.55	0.87	5.08	2.86	2.15	3.44	7.05	11.29	0.00	0.00	0.13	0.43
80.00	1.77	1.00	5.81	3.27	2.46	3.93	8.07	12.89	0.00	0.00	0.15	0.49
90.00	1.99	1.12	6.54	3.68	2.77	4.42	9.09	14.50	0.00	0.00	0.17	0.55
100.00	2.21	1.25	7.26	4.09	3.08	4.91	10.10	16.11	0.00	0.00	0.19	0.61
120.00	2.66	1.49	8.72	4.90	3.69	5.9	12.11	19.36	0.00	0.00	0.22	0.74
150.00	3.32	1.87	10.89	6.13	4.62	7.37	15.16	24.18	0.00	0.00	0.28	0.92
180.00	3.98	2.24	13.07	7.35	5.54	8.85	18.18	29.04	0.00	0.00	0.34	1.10
250.00	5.53	3.11	18.16	10.21	7.69	12.29	25.23	40.32	0.00	0.00	0.47	1.53
300.00	6.64	3.74	21.79	12.26	9.23	14.74	30.28	48.36	0.00	0.00	0.56	1.84

(image size and distance in meters and inches)

# ADDITIONAL INFORMATION

Diagonal length (inch) size of 16:9 Screen	Screen Size W x H				Projection Distance (D)				Min Offset (Hd)		Max Offset (Hd)	
	(m)		(inch)		(m)		(inch)		(m)	(inch)	(m)	(inch)
	Width	Height	Width	Height	Wide	Tele	Wide	Tele				
30.00	0.66	0.37	26.15	14.71	0.92	1.47	36.22	57.87	0.00	0.00	0.06	2.21
40.00	0.89	0.50	34.86	19.61	1.23	1.97	48.43	77.56	0.00	0.00	0.07	2.94
60.00	1.33	0.75	52.29	29.42	1.85	2.95	72.83	116.14	0.00	0.00	0.11	4.41
70.00	1.55	0.87	61.01	34.32	2.15	3.44	84.65	135.43	0.00	0.00	0.13	5.15
80.00	1.77	1.00	69.73	39.22	2.46	3.93	96.85	154.72	0.00	0.00	0.15	5.88
90.00	1.99	1.12	78.44	44.12	2.77	4.42	109.06	174.02	0.00	0.00	0.17	6.62
100.00	2.21	1.25	87.16	49.03	3.08	4.91	121.26	193.31	0.00	0.00	0.19	7.35
120.00	2.66	1.49	104.59	58.83	3.69	5.9	145.28	232.28	0.00	0.00	0.22	8.82
150.00	3.32	1.87	130.74	73.54	4.62	7.37	181.89	290.16	0.00	0.00	0.28	11.03
180.00	3.98	2.24	156.88	88.25	5.54	8.85	218.11	348.43	0.00	0.00	0.34	13.24
250.00	5.53	3.11	217.89	122.57	7.69	12.29	302.76	483.86	0.00	0.00	0.47	18.38
300.00	6.64	3.74	261.47	147.08	9.23	14.74	363.39	580.31	0.00	0.00	0.56	22.06

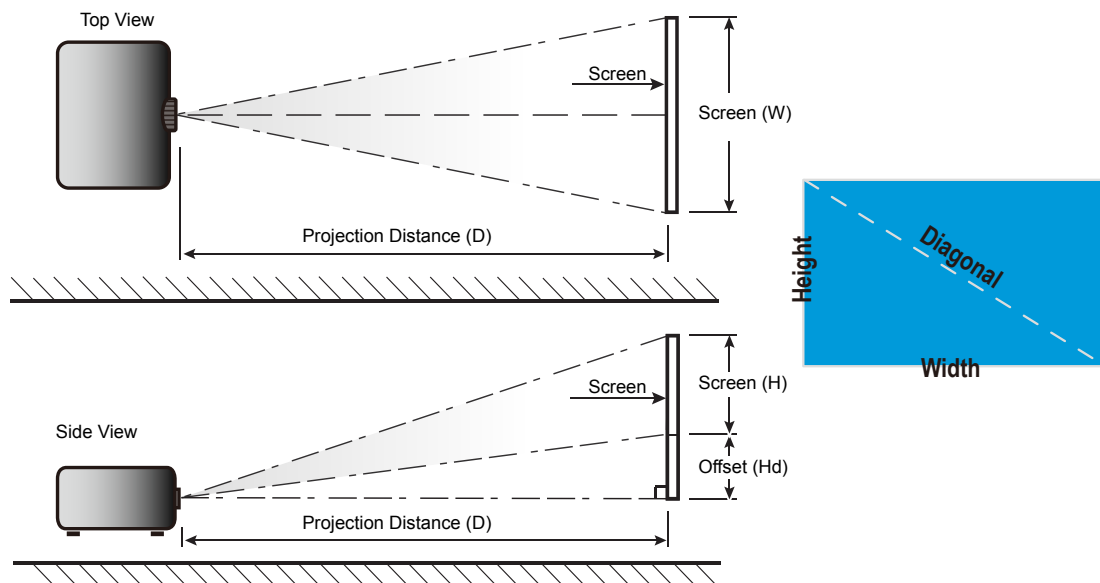

# ADDITIONAL INFORMATION

## Projector dimensions and ceiling mount installation

1. To prevent damage to your projector, please use the Optoma ceiling mount.
2. If you wish to use a third party ceiling mount kit, please ensure the screws used to attach a mount to the projector meet the following specifications:
  - Screw type: M6\*10
  - Minimum screw length: 10mm

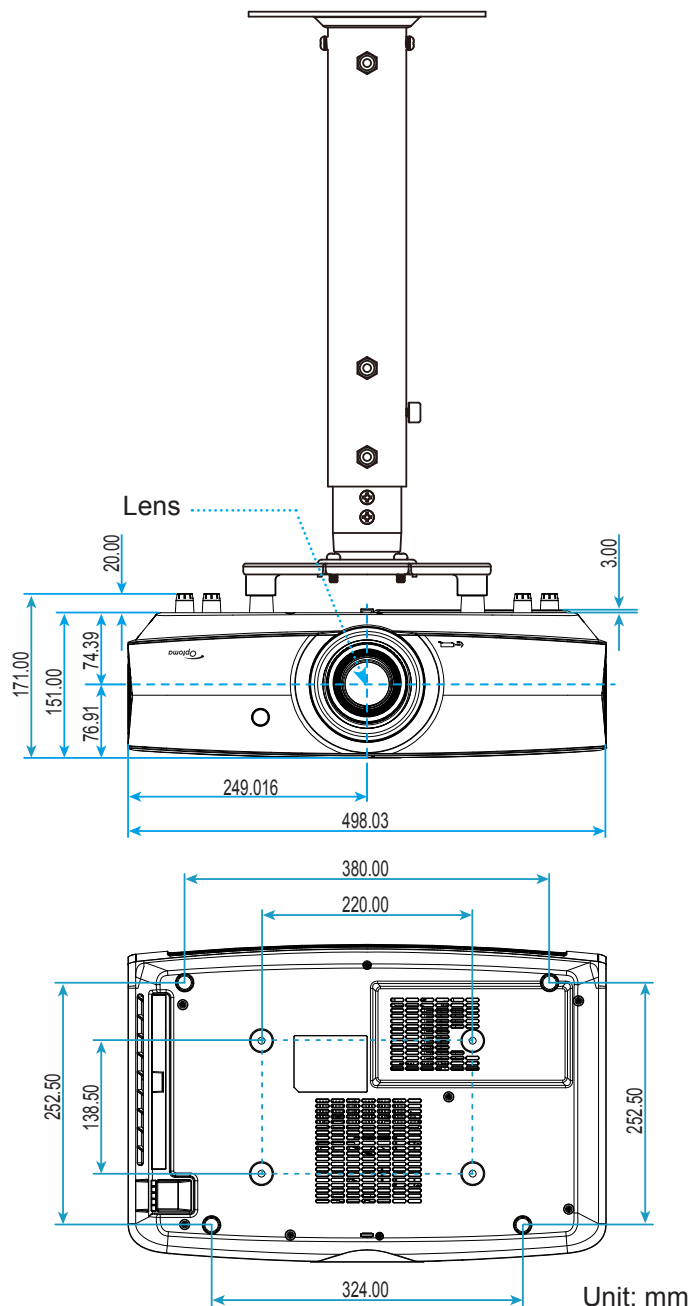

**Note:** Please note that damage resulting from incorrect installation will void the warranty.



Warning:

- If you buy a ceiling mount from another company, please be sure to use the correct screw size. Screw size will vary depending on the thickness of the mounting plate.
- Be sure to keep at least 10 cm gap between the ceiling and the bottom of the projector.
- Avoid installing the projector near a heat source.





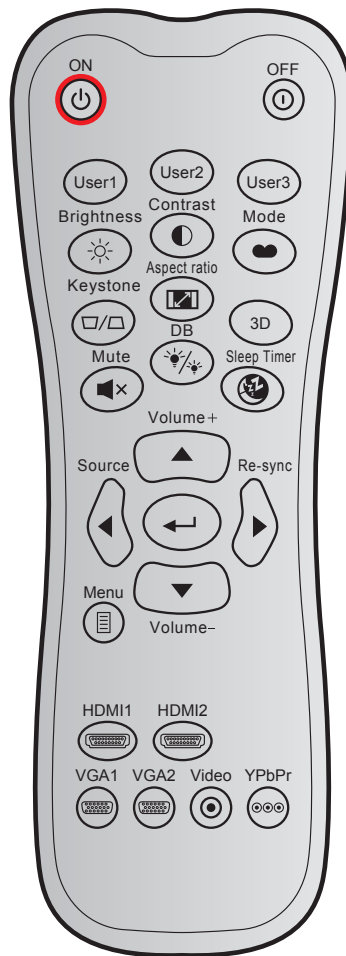







# ADDITIONAL INFORMATION

## IR remote codes



Key		Custom code		Data code	Printing-key definition	Description
		Byte 1	Byte 2	Byte 3		
Power on		32	CD	02	ON	Press to turn on the projector.
Power off		32	CD	2E	OFF	Press to turn off the projector.
User 1		32	CD	36	User1	User defined keys. Please see page 36 to setup.
User 2		32	CD	65	User2	
User 3		32	CD	66	User3	
Brightness		32	CD	41	Brightness	Adjust the brightness of the image.
Contrast		32	CD	42	Contrast	Control the degree of difference between the lightest and darkest parts of the picture.
Display mode		32	CD	05	Mode	Select a display mode for optimized settings for different applications. Please see page 29.
Keystone		32	CD	07	Keystone	No function
Aspect ratio		32	CD	64	Aspect ratio	Press to change aspect ratio of a displayed image.
3D		32	CD	89	3D	No function
Mute		32	CD	52	Mute	Momentarily turns off / on the audio.

# ADDITIONAL INFORMATION

Key		Custom code		Data code	Printing-key definition	Description
		Byte 1	Byte 2	Byte 3		
DB (Dynamic Black)		32	CD	44	DB	Automatically adjusts the picture brightness to give optimum contrast performance.
Sleep timer		32	CD	63	Sleep Timer	Sets the countdown timer interval.
Volume +		32	CD	09	Volume +	Adjust to increase volume.
Four direction keys		32	CD	11	▲	Use ▲, ◀, ▶, or ▼ to select items or make adjustments to your selection.
		32	CD	10	◀	
		32	CD	12	▶	
		32	CD	14	▼	
Source		32	CD	18	Source	Press "Source" to select an input signal.
Enter key		32	CD	0F		Confirm your item selection.
Re-sync		32	CD	04	Re-sync	Automatically synchronizes the projector to the input source.
Volume -		32	CD	0C	Volume -	Adjust to decrease volume.
Menu		32	CD	0E	Menu	Display or exit the on-screen display menus for projector.
HDMI 1		32	CD	16	HDMI1	Press "HDMI1" to choose source from HDMI 1 connector.
HDMI 2		32	CD	30	HDMI2	Press "HDMI2" to choose source from HDMI 2 connector.
VGA 1		32	CD	1B	VGA1	Press "VGA1" to choose source from VGA connector.
VGA 2		32	CD	1E	VGA2	No function
Video		32	CD	1C	Video	No function
YPbPr		32	CD	17	YPbPr	No function









# ADDITIONAL INFORMATION

## Troubleshooting

If you experience a problem with your projector, please refer to the following information. If a problem persists, please contact your local reseller or service center.

### Image problems

-  *No image appears on-screen*
- Ensure all the cables and power connections are correctly and securely connected as described in the "Installation" section.
  - Ensure the pins of connectors are not crooked or broken.
  - Ensure that the "Mute" feature is not turned on.
-  *Image is out of focus*
- Adjust the Focus Ring on the projector lens. Please see page 16.
  - Make sure the projection screen is between the required distance from the projector. (Please refer to pages 48-49).
-  *The image is stretched when displaying 16:9 DVD title*
- When you play anamorphic DVD or 16:9 DVD, the projector will show the best image in 16: 9 format on projector side.
  - If you play the LBX format DVD title, please change the format as LBX in projector OSD.
  - If you play 4:3 format DVD title, please change the format as 4:3 in projector OSD.
  - Please setup the display format as 16:9 (wide) aspect ratio type on your DVD player.
-  *Image is too small or too large*
- Adjust the zoom lever on the top of the projector.
  - Move the projector closer to or further from the screen.
  - Press "Menu" on the projector panel, go to "Display-->Aspect Ratio". Try the different settings.
-  *Image has slanted sides:*
- If possible, reposition the projector so that it is centered on the screen and below the bottom of the screen.
-  *Image is reversed*
- Select "Setup-->Projection" from the OSD and adjust the projection direction.

### Other problems

-  *The projector stops responding to all controls*
- If possible, turn off the projector, then unplug the power cord and wait at least 20 seconds before reconnecting power.

# ADDITIONAL INFORMATION

## Remote control problems

-  *If the remote control does not work*
- Check the operating angle of the remote control is pointed within  $\pm 15^\circ$  to the IR receiver on the projector.
  - Make sure there are not any obstructions between the remote control and the projector. Move to within 7 m (23 ft) of the projector.
  - Make sure batteries are inserted correctly.
  - Replace batteries if they are exhausted.

## Warning indicators

When the warning indicators (see below) light up or flash, the projector will automatically shutdown:

- "LASER" LED indicator is lit red and if "On/Standby" indicator flashes red.
- "TEMP" LED indicator is lit red and if "On/Standby" indicator flashes red. This indicates the projector has overheated. Under normal conditions, the project can be switched back on.
- "TEMP" LED indicator flashes red and if "On/Standby" indicator flashes red.

Unplug the power cord from the projector, wait for 30 seconds and try again. If the warning indicator light up or flash, please contact your nearest service center for assistance.

## LED lightning messages

Message	On/Standby LED		Temp LED	Laser LED
	(Red)	(Blue)	(Red)	(Red)
Standby state (Input power cord)	Steady light			
Power on (Warming)		Flashing (0.5 sec off / 0.5 sec on)		
Power on and laser lighting		Steady light		
Power off (Cooling)		Flashing (0.5 sec off / 0.5 sec light). Back to red steady light when cooling fan turns off.		
Error (Laser failure)	Flashing			Steady light
Error (Fan failure)	Flashing		Flashing	
Error (Over temp.)	Flashing		Steady light	
Standby State (Burn in mode)		Flashing		
Burn in (Warming)		Flashing		
Burn in (Cooling)		Flashing		
Burn in (Laser lighting)		Flashing (3 sec on / 1 sec off)		
Burn in (Laser off)		Flashing (1 sec on / 3 sec off)		

# ADDITIONAL INFORMATION

- Power off:

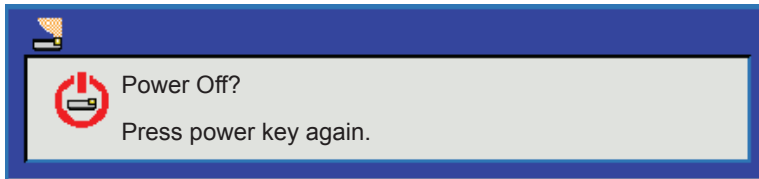

- Temperature warning:

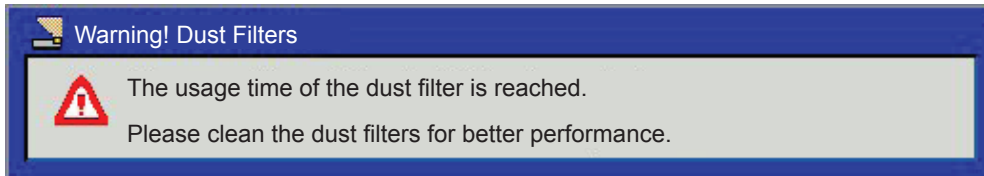

# ADDITIONAL INFORMATION

## Specifications

Optical	Description
Maximum resolution	- Graphic up to 2160p @ 60Hz - Maximum Resolution: HDMI1 : 1920 x 1200 @ 60Hz(RB) HDMI2 : 2160p @ 60Hz
Native resolution	(w/o actuator) 2716 x 1528
Lens	Manual zoom and manual focus
Image size (diagonal)	26.45"~302.2" focus range optimized to the image size 60"
Projection distance	1.3m ~ 9.3m focus range optimized @ wide 1.846m

Electrical	Description
Inputs	- HDMI 1.4a - VGA IN - Audio In 3.5mm - HDMI V2.0 HDCP2.2 / MHL 2.1 - USB-A - USB2.0 USB-A for 5V PWR 1.5A - RS232C male (9-pin D-SUB) - RJ-45 (support web control)
Outputs	- Audio Out 3.5mm - SPDIF Out - 12V Trigger (3.5mm jack)
Control	USB type A for mouse / service
Color reproduction	1073.4 Million color
Scan rate	Horizontal scan rate:31.000 ~ 135.000 KHz Vertical scan rate: 24 ~ 120 Hz
Built-in speaker	Yes, 4W
Power requirement	100 - 240V ±10%, AC 50/60Hz
Input current	4.5A

Mechanical	Description
Installation orientation	Front, Rear, Ceiling - Front, Rear - top
Dimensions	498.1 mm (W) x 331 mm (D) x 154 mm (H) (without feet)
Weight	<10 kg
Environmental conditions	Operating in 5 ~ 40°C , 10% to 85% humidity (non-condensing)

**Note:** All specifications are subject to change without notice.



# ADDITIONAL INFORMATION

## Optoma global offices

For service or support, please contact your local office.



### USA

3178 Laurelview Ct.  
Fremont, CA 94538, USA  
www.optomausa.com

 888-289-6786  
 510-897-8601  
 [services@optoma.com](mailto:services@optoma.com)



### Canada

3178 Laurelview Ct.  
Fremont, CA 94538, USA  
www.optomausa.com

 888-289-6786  
 510-897-8601  
 [services@optoma.com](mailto:services@optoma.com)



### Latin America

3178 Laurelview Ct.  
Fremont, CA 94538, USA  
www.optomausa.com

 888-289-6786  
 510-897-8601  
 [services@optoma.com](mailto:services@optoma.com)



### Europe

Unit 1, Network 41, Bourne End Mills  
Hemel Hempstead, Herts,  
HP1 2UJ, United Kingdom  
www.optoma.eu  
Service Tel : +44 (0)1923 691865

 +44 (0) 1923 691 800  
 +44 (0) 1923 691 888  
 [service@tsc-europe.com](mailto:service@tsc-europe.com)



### Benelux BV

Randstad 22-123  
1316 BW Almere  
The Netherlands  
www.optoma.nl

 +31 (0) 36 820 0252  
 +31 (0) 36 548 9052



### France

Bâtiment E  
81-83 avenue Edouard Vaillant  
92100 Boulogne Billancourt, France

 +33 1 41 46 12 20  
 +33 1 41 46 94 35  
 [savoptoma@optoma.fr](mailto:savoptoma@optoma.fr)



### Spain

C/ José Hierro,36 Of. 1C  
28522 Rivas VaciaMadrid,  
Spain

 +34 91 499 06 06  
 +34 91 670 08 32



### Deutschland

Wiesenstrasse 21 W  
D40549 Düsseldorf,  
Germany

 +49 (0) 211 506 6670  
 +49 (0) 211 506 66799  
 [info@optoma.de](mailto:info@optoma.de)

### Scandinavia



Lerpeveien 25  
3040 Drammen  
Norway

 +47 32 98 89 90  
 +47 32 98 89 99  
 [info@optoma.no](mailto:info@optoma.no)

PO.BOX 9515  
3038 Drammen  
Norway

### Korea

WOOMI TECH.CO.,LTD.  
4F, Minu Bldg.33-14, Kangnam-Ku,  
Seoul,135-815, KOREA  
korea.optoma.com

 +82+2+34430004  
 +82+2+34430005

### Japan

東京都足立区綾瀬3-25-18  
株式会社オーエス  
コンタクトセンター:0120-380-495

 [info@os-worldwide.com](mailto:info@os-worldwide.com)  
[www.os-worldwide.com](http://www.os-worldwide.com)



### Taiwan

12F., No.213, Sec. 3, Beixin Rd.,  
Xindian Dist., New Taipei City 231,  
Taiwan, R.O.C.  
www.optoma.com.tw

 +886-2-8911-8600  
 +886-2-8911-6550  
 [services@optoma.com.tw](mailto:services@optoma.com.tw)  
[asia.optoma.com](http://asia.optoma.com)



### Hong Kong

Unit A, 27/F Dragon Centre,  
79 Wing Hong Street,  
Cheung Sha Wan,  
Kowloon, Hong Kong

 +852-2396-8968  
 +852-2370-1222  
[www.optoma.com.hk](http://www.optoma.com.hk)

### China

5F, No. 1205, Kaixuan Rd.,  
Changning District  
Shanghai, 200052, China

 +86-21-62947376  
 +86-21-62947375  
[www.optoma.com.cn](http://www.optoma.com.cn)



P/N:36.7AL01G001-A